



By Appointment to
Her Majesty Queen Elizabeth II
Suppliers of Commercial Refrigeration
Foster Refrigerator, King's Lynn

EcoPro G2 Cabinets & Counters

FD1-11 Controller & Display

English



June 2019 Version 2



A Division of ITW Ltd
Foster Refrigerator,
Oldmedow Road,
King's Lynn,
Norfolk, PE30 4JU
United Kingdom

Call: +44 (0)843 216 8800

Fax: +44 (0)843 216 4700

Email: support@foster-uk.com

www.fosterrefrigerator.co.uk

Contents

Manual Information & Health & Safety Notes	1
Environmental Management Policy	2
Disposal Requirements & Electrical Safety	2
EcoPro G2 Cabinet Description	3
Display Icons & Switches	3
Start up, Standby, User Adjustments	4
Temperature Sensitivity, Key Security, Light Function, Downloading, Defrost Function & Reduced Energy Control.	5
FD1-11 Controller Connection Drawing, Technical Data & Configuration of Parameters	6
Default Parameters Explained	7 to 12
Individual EcoPro G2 Cabinet Parameter Values	13 to 15
Technical Data	16 to 17
Wiring Diagrams & Probe details	18 to 20
Individual EcoPro G2 Counters parameters, wiring diagrams & probe details	21 to 26
Troubleshooting & Notes	27 to 30

Service Manual Information:

The products and all information in this manual are subject to change without prior notice. We assume by the information given that the person(s) working on these refrigeration units are fully trained and skilled in all aspects of their workings. Also that they will use the appropriate safety equipment and take or meet precautions where required. The service manual does not cover information on every variation of this unit; neither does it cover the installation or every possible operating or maintenance instruction for the units.

Health & Safety Warnings and Information



Make sure the power supply is turned off before making any electrical repairs.



To minimise shock and fire hazards, please do not plug or unplug the unit with wet hands.



During maintenance and cleaning, please unplug the unit where required.



Care must be taken when handling or working on the unit as sharp edges may cause personal injury, we recommend the wearing of suitable PPE.



Ensure the correct moving and lifting procedures are used when relocating a unit.



Do NOT use abrasive cleaning products, only those that are recommended. Never scour any parts of the refrigerator. Scouring pads or chemicals may cause damage by scratching or dulling polished surface finishes.



Failure to keep the condenser clean may cause premature failure of the motor/compressor which will NOT be covered under warranty policy.



Do NOT touch the cold surfaces in the freezer compartment. Particularly when hands are damp or wet, skin may adhere to these extremely cold surfaces and cause frostbite.



Please ensure the appropriate use of safety aids or Personnel Protective Equipment (PPE) are used for you own safety.



Environmental Management Policy

Product Support and Installation Contractors.

Foster Refrigerator recognises that its activities, products and services can have an adverse impact upon the environment.

The organisation is committed to implementing systems and controls to manage, reduce and eliminate its adverse environmental impacts wherever possible, and has formulated an Environmental Policy outlining our core aims. A copy of the Environmental Policy is available to all contractors and suppliers upon request.

The organisation is committed to working with suppliers and contractors where their activities have the potential to impact upon the environment. To achieve the aims stated in the Environmental Policy we require that all suppliers and contractors operate in compliance with the law and are committed to best practice in environmental management.

Product Support and Installation contractors are required to:

1. Ensure that wherever possible waste is removed from the client's site, where arrangements are in place all waste should be returned to Foster Refrigerator's premises. In certain circumstances waste may be disposed of on the client's site; if permission is given, if the client has arrangements in place for the type of waste.
2. If arranging for the disposal of your waste, handle, store and dispose of it in such a way as to prevent its escape into the environment, harm to human health, and to ensure the compliance with the environmental law. Guidance is available from the Environment Agency on how to comply with the waste management 'duty of care'.
3. The following waste must be stored of separately from other wastes, as they are hazardous to the environment: refrigerants, polyurethane foam, and oils.
4. When arranging for disposal of waste, ensure a waste transfer note or consignment note is completed as appropriate. Ensure that all waste is correctly described on the waste note and include the appropriate six-digit code from the European Waste Catalogue. Your waste contractor or Foster can provide further information if necessary.
5. Ensure that all waste is removed by a registered waste carrier, a carrier in possession of a waste management licence, or a carrier holding an appropriate exemption. Ensure the person receiving the waste at its ultimate destination is in receipt of a waste management licence or valid exemption.
6. Handle and store refrigerants in such a way as to prevent their emission to atmosphere, and ensure they are disposed of safely and in accordance with environmental law.
7. Make arrangements to ensure all staff who handle refrigerants do so at a level of competence consistent with the City Guilds 2078 Handling Refrigerants qualification or equivalent qualification.
8. Ensure all liquid substances are securely stored to prevent leaks and spill, and are **not** disposed of into storm drains, foul drain, or surface water to soil.

Disposal Requirements

If not disposed of properly all refrigerators have components that can be harmful to the environment.

All old refrigerators must be disposed of by appropriately registered and licensed waste contractors, and in accordance with national laws and regulations.

General Electrical Safety

Foster Refrigerator recommends that the equipment is electrically connected via a Residual Current Device; such as a Residual Current Circuit Breaker (RCCB) type socket, or through a Residual Current Circuit Breaker with Overload Protection (RCBO) supplied circuit.

EcoPro G2 Cabinet Description

The EcoPro G2 range comes as a Full Gastronorm format in a variety of capacities and temperatures. A standard unit comes with 2/1 shelves (3 with a single model, 6 with a double model).

The fish model comes fitted with fixed racking to take 7 fish boxes (198kgs) as standard whereas the wine version comes with a racking assembly that holds either 140x75cl bottles (for a single model) or 280 x 75cl (for a double model).

The units are manufactured as a one piece shell with easy clean stainless steel exterior. Each conforms to the current legislation and exceeds the Montreal protocol by using zero ODP (ozone depleting substances) refrigerants and insulation. There is also the added option of having Hydrocarbon refrigerant with certain model variations.

Each unit's temperature is controlled by a microprocessor with digital temperature display. There are several temperature options available exceeding the Climate Class 5 operations by giving an ambient temperature to 43°C.

Each temperature display is also easy to read with a wipe clean finish.

The standard form of refrigeration system in this unit is integrated with an air-cooled condensing unit that allows cooled air to circulate through the evaporator, via the fan into storage areas. It does this by distributing the refrigerant into the evaporator controlled by a capillary.

Remote systems are also available as an option, the difference being, the evaporator is controlled by an expansion valve instead of capillary.

Other points to be made on these units are that they have coated coils to prevent corrosion and to help prolong the refrigerator's life.

Cabinets come with an easily removable plug box and lid.

Display Icons and Switches

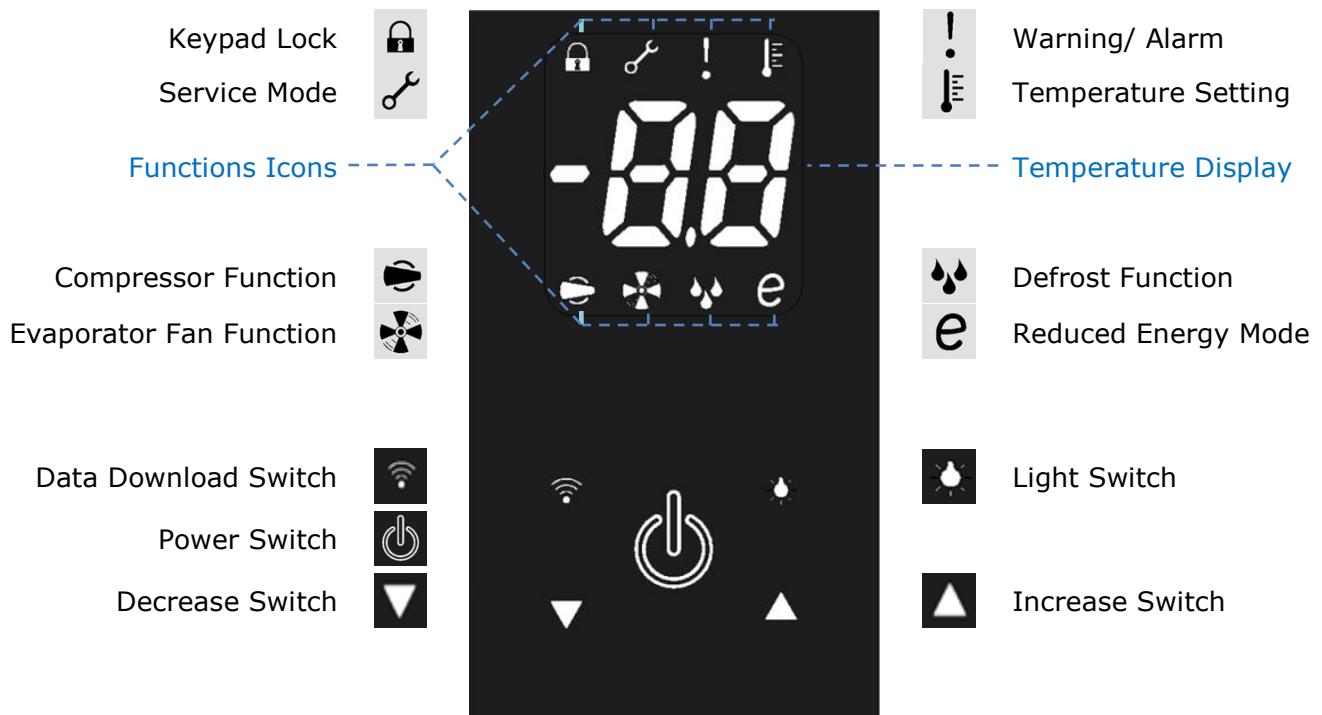

(Some icons or switches are only visible during adjustment, when activated by parameters or through operation/manual selection).

Start-Up and Operation

Initial Set Up

After unpacking clean and allow the cabinet to stand for 2 hours before turning on.

Ensure the cabinet is situated where neither hot nor cold air sources will affect its performance. Make sure that a minimum clearance of 310mm above and 50mm around the cabinet is available for ventilation and effective operation.

Initial Start up

Connect the unit to a suitable mains power outlet and turn the supply on. Please do not plug or unplug the unit with wet hands.

The cabinet will energise briefly showing followed by the power switch slowly pulsing with a blank display. The unit is now in standby.

Standby

Pressing this switch for 3 seconds will turn the unit on (the switch backlight is static and the display shows the operating temperature) or put into standby (the switch backlight pulses slowly on & off). As the operating temperature has been pre-set no adjustments are required. Allow the cabinet to reach its normal/set operating temperature before loading.

User Adjustments Mode

You are required to enter this mode to make any setup changes.

These include Set Point, Keypad Security, and display of T1, 2 or 3 probe temperatures.

Press and immediately release , after which the and switches will flash/pulse together.

Press to scroll through the following screens:

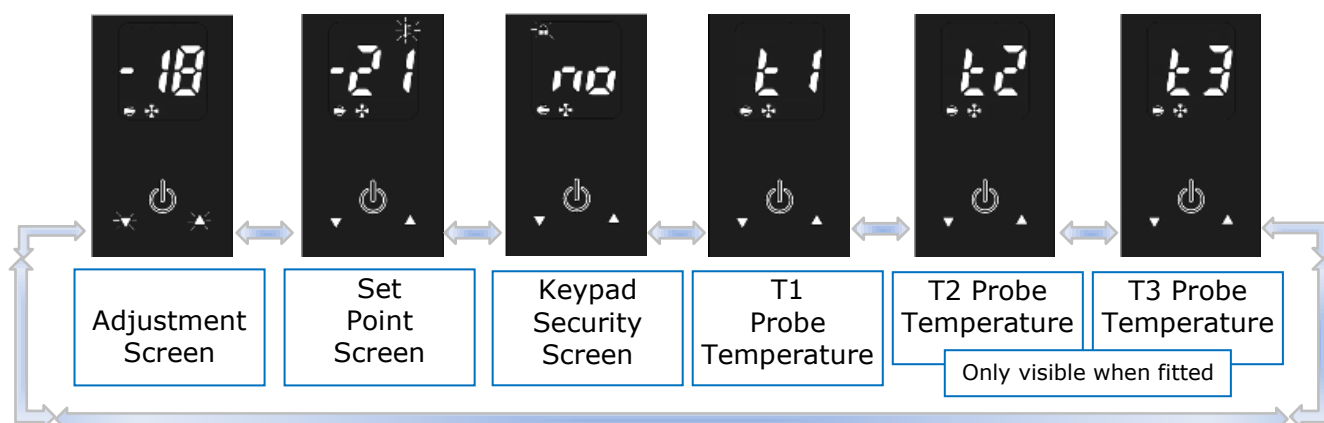

To exit this mode scroll back to the adjustment screen and press or wait for 30 seconds and the display will revert to the normal display showing the operating temperature.

Set Point and Other Mode Adjustments

Access the adjustment mode as described above. Using the or switches to scroll to the mode that requires adjustment i.e. 'Set Point' this is the minimum temperature the cabinet is allowed to cool down to (the display shows the temperature and flash/pulsing icon).

To adjust this press and release the icon will show constantly. Adjust the setting with the or switch. Confirm the change by pressing and releasing again, the next mode will automatically show. Scroll through the modes with the or switch until you return to the adjustment screen and press and release to exit and save.

If at any point the display is left for 30 seconds it will revert to the normal display and no changes will be saved.

Increased Sensitivity of Temperature Settings







If you require the cabinet to have a more accurate or increased sensitivity to temperature and the warnings this controls, the controller is able to measure temperature in 1/10^{ths} of a degree (0.1°) instead of whole degrees.

With parameter 'SC' set to '1C' the display will show the temperature as 1/10^{ths} of a degree on the scale between -9.9°C to +9.9°C.



Also, with parameter 'SC' set to '1F' the controller has the facility to show the temperature in Fahrenheit (between -58°F to 99°F). However if this is selected all other temperature related parameter values will have to be set accordingly to this change. (See 'Configuration of Parameters' for information on how to access this).

Keypad Security Settings

Access the 'Keypad Security' screen as described before.

The screen will show the current status, initially pre-set to 'run', with  flashing. Press and release  and  will show constantly. (If you modify this setting with  to show '49' the keypad will be locked,  will show constantly and the cabinet will not be able to be put into standby, carry out a manual defrost, adjust temperature set point, download data or switch on/off the units lights. To confirm any change you **must** press  again so the next screen  shows). Exit any of the 'Adjustment Modes' as described before.

Internal Light (where fitted)

To switch on the lights press and release  so that the switch backlight is on continuously. To switch off press and release  and the switch backlight will flash/pulse.

Downloading Data

This option is only available when enabled via parameters and the cabinet has the additional FCOM1 device available –this availability will be shown by the data switch being constantly illuminated.

To download the data the  switch should be pressed and then released. The information will then begin downloading to the appropriate printer or PC and the backlight of the switch will flash. On completion the switch will return to constant state of illumination.

Defrost

All Foster G2 cabinets are fitted with a fully automatic defrost system to ensure that the evaporator coil remains free from ice during normal use. Melt-water is evaporated using either the heat from the refrigeration system or a separate electric heater (dependent upon model and configuration).

To activate a manual defrost – while the cabinet is in 'run' mode press and hold  for 5 seconds. After 3 seconds the display will go blank then return after a further 2 seconds. At this point a defrost will be performed (subject to underlying operating parameters), this will terminate automatically.

Reduced Energy Control Mode

The reduced energy control mode ('e' mode) detects when the unit has reached the selected temperature set-point and the operating conditions (such as usage rate) have become less demanding.

When enabled, the controller will modify the compressor, evaporator fan and defrost operation in order to reduce the energy consumed. During the reduced energy control mode  is illuminated at the bottom right corner of the display.

Upon an increase in operating demand the controller reverts back to the standard operating settings with the  symbol extinguished. The 'e' mode is enabled by setting parameter 'iiM' to 'Au'. Further parameter settings ('iiS', 'iit', 'iiP', 'iiY', 'iiF', 'iid', and 'iiE') control the temperature cycle during the reduced energy control mode. Setting parameter 'iiM' to 'no' disables the 'e' mode.

FD1-11 Controller Connection Drawing

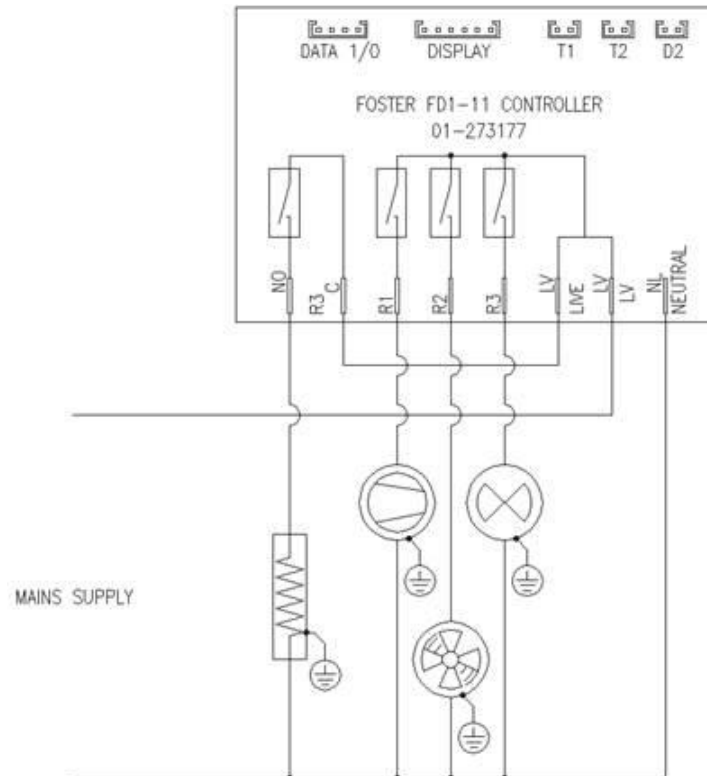

FD1-11 Technical Data

Power Supply

FD1-11
230Vac \pm 10%,
50/60Hz, Operating 3.2W, Standby 0.9W

Relay Output

Compressor - 16(8) A 240Vac
Defrost - 16(4) A 240Vac

Evap. Fan - 16(4) A 240Vac
Auxiliary Loads 1 - 8(2) A 240Vac

Input

NTC 10K Ω @25°C

Measurement Range

-50...120°C, -55...240°F
-50 / -9.9...19.9 / 80°C (NTC 10K Only)

Measurement Accuracy











<0.5°C within the measurement range

CE (Reference norms)

EN60730-1; EN60730-2-9
EN55022 (Class B)
EN50082-1

Configuration of Parameters

Parameters should not be changed unless you have an understanding of their purpose and the following instructions are fully understood.

- To gain access to the parameters use the 'Adjustment Mode'. This is accessed by pressing and releasing the  switch. After selecting this mode press and hold  and  together for 5 seconds. The first parameter will show on the display.
- Using the  and  switches you can scroll through all parameters and their values.
- If you wish to change a parameter value press and release the  switch when one of the desired mnemonics. Once selected in this way use the  and  switches to modify. When the new required value is shown it will be saved by pressing and releasing the  switch. After which the display will show the next parameter.
- To exit this mode or revert to normal operating mode, press  and  together then release.

If at any point no buttons are pressed for 30 seconds without saving a new value the display will return to the standard temperature display without changes being made.

EcoPro G2 FD1-11 Controller Default Parameter Values

Para	Cond	Range	Description	Dim	FD1-11	
SL		-50 ... SH	Minimum limit for 'SP' setting	°C	1	
SH		SL ... 90°	Maximum limit for 'SP' setting	°C	3	
SP		SL ... SH	Temperature set point to be achieved	°C	1.5	
CH		RF - HE	Refrigeration or Heating control mode	Flag	RF	
HY		1 ... 9.9°	Off/On thermostat differential	°K	3	
CR		0 ... 30min	Compressor Rest Time	Min	2	
C1		0 ... 30min	Thermostat run times with faulty T1 probe ('C' = 0 output with faulty T1 will always be off).	Min	6	
C2		0 ... 30min	Thermostat run times with faulty T1 probe ('C1' = '0' & 'C1' => '0' output with faulty T1 will always be on	Min	4	
CS		0 ... 30min	Compressor stop delay after door has been opened (only if 'DS' = '1')	Min	1	
DM			Defrost start mode:	Func.	TM	
		NO	Defrost is disabled (the following parameter will be 'FM')			
		TM	Regular time defrost			
		FR	Defrost time elapses only in condition of frost accumulation			
DB	'DM' = 'TM' or 'FR'	0 ... 90 Hrs	Time interval between defrosts	Hrs	6	
DF			Defrost timer clock:	Flag	YS	
			YS			Following mains interruption, timer resumes count
		NO	Following mains interruption, timer restarts from zero			
DL			-50 ... 90°	Defrost end temperature (only if 'T2' = '1')	°C	15
DT			1 ... -0min	Maximum defrost duration	Min	20
DY				Defrost type:	Func.	OF
			OF	Timed off cycle defrost (compressor and heater off)		
			EL	Electric heater defrost (compressor and heater on).		
		GS	Hot gas defrost (compressor and heater on)			
DS				Defrost synchronisation:	Func.	HI
			OF	No synchronisation (defrost occurs immediately when scheduled).		
			LO	Defrost waits until T1 = lowest part of cycle (when compressor would normally 'cut-off').		
		HI	Defrost waits until T1 = highest part of cycle (when compressor would normally 'cut-in').			
ST			0 ... 30min	Defrost synchronisation time out when 'DS' = 'LO' to provide maximum time defrost can be deferred.	Min	5
DP		0 ... 90sec	Evaporator pump down. Timed pause at start of defrost	Sec	0	
DR		0 ... 20sec	Defrost pressure reduction. At end of defrost, time compressor continues running after hot gas solenoid valve shuts	Sec	3	
DN		0 ... 30min	Drain down period	Min	1	

DD	'DM' = 'TM' or 'FR'		Defrost display mode:	Func.	SP
		RT	Real (actual) air temperature		
		LT	Last temperature display before start of defrost		
		SP	The current set point value		
		DF	Display will show 'dp'.		
DH		0 ... 60min	Defrost display delay period. Time 'DD' is shown following defrost termination.	Min	3
FD			Fans in defrost:	Flag	YS
		YS	Fans run during defrost		
		NO	Fans do not run during defrost		
FR		-50 ... 90°	Evaporator fan restart temperature following defrost. (Only if 'T2' = '1').	°C	5
FS	0 ... 90min	Maximum evaporator fan stop period defrost (only when 'T1' = '1').	Min	3	
FM			Evaporator fan mode during thermostatic control:	Func.	TM
	NO	Fan(s) run continuously (subject to door & defrost).			
	TP	Temperature based control. When compressor is on, fans are on.			
	TM	When compressor is off, fans run as long as temperature difference $T_e - T_a > 'FT'$. Fans on again with 'FH'.			
FT	-9.9 ... 0°	$T_e - T_a$ difference for fans to turn off after compressor stopped. (Only if 'T2' - 'YS' and 'FM' = 'TM')	°K	-1	
FH	1 ... 9.9°	Temperature differential for evaporator fan restart (Only if 'T2' - 'YS' and 'FM' = 'TM')	°K	3	
F1	0 ... 90sec	Evaporator fan stop delay after compressor stop	Sec	10	
F2	0 ... 90sec	Timed fan stop following 'F1' (With F2 = '0' the fans remain on all the time).	Sec	30	
F3	0 ... 90sec	Timed fan stop following 'F2' (With F3 = '0' & F2 > 0 the fans remain off all the time).	Sec	20	
FP	0 ... 90sec	Minimum evaporator fan stop period (following door opening etc.).	Sec	20	
AT			Alarm threshold configuration:	Func.	RL
	NO	All temperature alarms are inhibited (the following parameter will be 'AO').			
	AB	The value set in 'AL' & 'AH' represent actual alarm set points			
	RL	The values set in 'AL' & 'AH' are alarm differentials which relate to 'SP' and 'SP' + 'HY' (the following parameter will be 'LD')			
AL	'AM' = 'AB'	-50 ... 90°	Low temperature alarm threshold	°C	-3
AH		-50 ... 90°	High temperature alarm threshold *the following parameter will be 'AI').	°C	8
LD	'AM' = 'RL'	-9.9 ... 0°	Low temperature differential (With 'LD' = '0' the low temperature alarm is excluded)	°K	-5
HD		0 ... 9.9°	High temperature differential (With 'HD' = '0' the low temperature alarm is excluded).	°K	5

AI	'AM' = 'AB' or 'RL'		Alarm Probe:	Func.	T1
		T1	Air temperature probe used for alarm detection		
		T2	Evaporator temperature probe used for alarm detection (if 'T2' = 'YS').		
		T3	Third temperature probe used for alarm detection (if 'D2' = 'T3').		
AD		0 ... 90min	Delay before alarm temperature warning	Min	90
AO		0 ... 30min	Delay before door open alarm warning (only when 'D1' or 'D2' = 'DS')	Min	5
PF		0 ... 30°	Power failure alarm differential. (With 'PF' = '0' power failure alarm is disabled).	°K	10
AM			Operation in case of high condenser alarm (if 'D2'='T3' and 'T3'='CD'):	Func.	NO
		NO	High condenser temperature alarm inhibited		
		AP	Condenser warning – 'HC' displayed, alarm sounds, operation continues.		
		ST	As 'AP' above, but compressor stopped (R1 de-energised) and defrosts suspended.		
AS		-50 ... 90°	Condenser alarm temperature (if 'D2' = 'T3').	°C	65
AF			Operation in case of high pressure alarm (if 'D2' = 'HP'):	Func.	ST
		AP	Pressure warning – 'HP' displayed, alarm sounds, operation continues.		
		ST	As 'AP' above, but compressor stopped (R1 de-energised) and defrosts suspended.		
		SA	All relays de-energised while condition exists.		
AC		0 ... 52 wks.	Condenser cleaning period. (With 'AC' = '0' condenser cleaning alarm is disabled)	Wks.	0
IIM			Switchover method to reduced energy mode:	Func.	AU
		NO	Reduced energy model is excluded (the following parameter will be 'DC').		
		AU	Reduced energy mode is activated/ de-active automatically via 'IIS' and 'IIT'		
		D2	Second parameter set activated by 'D2' input ('D2' = 'IIM')		
IIS	IIM = 'AU' or 'D2'	1 ... 90min	Minimum 'non activity' time for reduced energy mode	Min	20
IIT		1 ... 10°	Maximum temperature 'addition' for reduced energy mode	°C	6
IIP		1 ... 50°	Reduced energy mode temperature set point – differential above 'SP' (refrigerating) below 'SP' (heating).	°K	2
Iiy		1 ... 10°	Reduced energy mode 'off/on' thermostat differential.	°K	3

IIF	IIM = 'AU' or 'D2'		Evaporator fan control during 'Reduced Energy' operation:	Func.	TM
		NO	Fan(s) run continuously		
		TP	Temperature based control. When compressor is on, fans are on. When compressor is off, fans run as long as temperature difference $T_e - T_a > 'FT'$. Fans on again with 'FH'.		
		TM	Time based control. When compressor is on, fans are on. When compressor is off, fans in accordance to parameters 'F1', 'F2' and 'F3'.	Hrs.	12
IID		0 ... 90 Hrs	Time interval between defrosts in reduced energy mode.		
IIE			Display during reduced energy mode		
		RT	Real (actual) air temperature		
		LT	Last temperature display before reduced energy mode.		
		IIP	The calculated set point value ('SP' + 'IIP')		
DC				Data collection and download function (FCOM fitted):	Flag
	YS	Data collection/download function enabled via switch (L3 illuminated)			
	NO	Data collection/download function disabled.			
SB			Standby Button operation:	Flag	YS
	YS	Standby button enabled			
	NO	Standby button disabled			
DO			Configurable digital input operation:	Func.	DS
	NO	Digital input not activated			
	DS	Door switch input			
	AO	Alarm ('AL' displayed) when contact opens.			
	AC	Alarm ('AL' displayed) when contact closes.			
D1			Configurable digital input operation:	Func.	NO
	NO	Digital input not activated			
	DS	Door switch input			
	AO	Alarm ('AL' displayed) when contact opens.			
	AC	Alarm ('AL' displayed) when contact closes.			
D2			Configurable digital input operation:	Func.	NO
	NO	Digital input not activated			
	DS	Door switch input			
	AO	Alarm ('AL' displayed) when contact opens.			
	AC	Alarm ('AL' displayed) when contact closes.			
	HP	High pressure switch input (normally closed/ alarm when open).			
	IIM	Operates reduced energy mode when contact closes.			
T3	Allows for 3 rd temperature probe function.				

T3	'D2' = 'T3'		T3 probe function (only when 'D2' = 'T3'):	Flag	DP
		DP	T3 probe temperature displayed		
		CD	Condenser temperature measurement		
O3		-9.9 ... 9.9°C	T3 probe temperature offset (only when 'D2' = 'T3'):	°K	0
LM			Light control mode (if 'R3' = 'LM'):	Func.	NO
		NO	Light control mode disabled (always off)		
		MN	Light output operation is activated/deactivate by switch (L5 illuminated).		
		00	Light output is switched on when door is opened (if 'D1' = 'DS').		
		10	Light output is switched on when door is closed (if 'D1' = 'DS').		
		20	Light output is switched on when door is opened (if 'D2' = 'DS').		
		2C	Light output is switched on when door is closed (if 'D2' = 'DS').		
R2			Relay 2 operation:	Func.	EF
		NO	Output disabled (always off).		
		EF	Control of evaporator fan.		
		DF	Control of defrost heater/device (activated when 'DY' = 'EL' or 'GS'),		
		LM	Output enabled for light control.		
		01	Contacts open/close with 'Standby'/'on' mode ('SB' = '1')		
		AO	Contacts open when an alarm condition occurs		
		AC	Contacts close when an alarm condition occurs		
	(Relay contacts open when in standby mode).				
R3			Relay 3 operation:	Func.	NO
		NO	Output disabled (always off).		
		EF	Control of evaporator fan.		
		DF	Control of defrost heater/device (activated when 'DY' = 'EL' or 'GS'),		
		LM	Output enabled for light control.		
		01	Contacts open/close with 'Standby'/'on' mode ('SB' = '1')		
		AO	Contacts open when an alarm condition occurs		
		AC	Contacts close when an alarm condition occurs		
	(Relay contacts open when in standby mode).				

R4			Relay 4 operation:	Func.	NO
		NO	Output disabled (always off).		
		EF	Control of evaporator fan.		
		DF	Control of defrost heater/device (activated when 'DY' = 'EL' or 'GS'),		
		LM	Output enabled for light control.		
		01	Contacts open/close with 'Standby'/'on' mode ('SB' = '1')		
		AO	Contacts open when an alarm condition occurs		
		AC	Contacts close when an alarm condition occurs		
		(Relay contacts open when in standby mode).			
O1		-9.9 ... 9.9°C	Air temperature probe (T1) offset	°K	0
T2			T2 probe enabling:	Flag	0
		YS	T2 probe enabled		
		NO	T2 probe disabled		
O2		-9.9 ... 9.9°C	Evaporator temperature probe (T2) offset	°K	0
SC			Readout scale:	Func.	2C
		1C	Range -50 ... 99°C (0.1°C resolution within -9.9 to +9.9°C)		
		2C	Range -50 ... 99°C		
		1F	Range -58 ... 99°F		
SM		0 ... 99	Display slowdown	Func.	5
AR		1 ... 64	FD1-11 address for PC communication	Flag	1



Individual EcoPro G2 Cabinets Parameter Values

Version		1	2	3	4	5	6	7	8	9	10	12	13	14	16	17	18	19	20	21	23	24	25	26	28	29	31	32	33	34	35	36	37	38	39			
Par																																						
FD1-11 Default	SL	1	1	1	1	1	1	1	1	1	1	1	1	1	1	1	1	1	1	1	1	1	1	1	1	1	1	1	1	1	1	1	1	1	1			
	SH																																					
	SP	1.5	-1	1.5	1.5	1.5	1.5	1.5	2	1	1.5	1.5	3	3	-19	-21	-21	-21	5	-18	-21	-21	-21	-21	-19	-21	8	8	8	10	12	8	1	-2	-2			
	CH	RF	RF	RF	RF	RF	RF	RF	RF	RF	RF	RF	RF	RF	RF	RF	RF	RF	RF	RF	RF	RF	RF	RF	RF	RF	RF	RF	RF	RF	RF	RF	RF	RF	RF			
	HY	3	2	3	3	3	3	3	3	3	3	3	3	3	3	3	3	3	3	3	3	3	3	3	3	3	3	3	3	3	3	3	3	3	3			
	CR	2	2	2	0	0	2	2	2	4	2	0	0	0	2	2	2	5	2	2	2	2	2	2	2	2	2	2	0	2	2	2	2	2	2	2		
	C1	6	6	6	6	6	6	6	6	6	6	6	6	6	6	6	6	6	6	6	6	6	6	6	6	6	6	6	6	6	6	6	6	6	6	6		
	C2	4	4	4	4	4	4	4	4	4	4	4	4	4	4	4	4	4	4	4	4	4	4	4	4	4	4	4	4	4	4	4	4	4	4	4	4	
	CS	1	1	1	1	1	1	1	1	1	1	1	1	1	1	1	1	1	1	1	1	1	1	1	1	1	1	1	1	1	1	1	1	1	1	1	1	
	DM	TM	NO	TM	TM	TM	TM	TM	TM	TM	TM	TM	TM	TM	TM	TM	TM	TM	TM	TM	TM	TM	TM	TM	TM	TM	TM	TM	TM	TM	TM	TM	TM	TM	TM	TM	TM	
	DB	6	6	6	6	6	6	6	8	6	6	6	6	6	6	6	6	6	6	6	6	6	6	6	6	6	6	6	6	6	6	6	6	6	6	6		
	DF	YS	YS	YS	YS	YS	YS	YS	YS	YS	YS	YS	YS	YS	YS	YS	YS	YS	YS	GS	GS	GS	GS	GS	GS	GS	GS	GS	GS	GS	GS	GS	GS	GS	GS	GS	GS	
	DL	15	15	15	15	15	15	15	15	15	15	15	15	15	15	15	15	15	15	15	15	15	15	15	15	15	15	15	15	15	15	15	15	15	15	15	15	
	DT	20	20	20	20	20	20	20	20	20	20	20	20	20	20	20	20	20	20	20	20	20	20	20	20	20	20	20	20	20	20	20	20	20	20	20	20	
	DY	OF	OF	OF	OF	OF	OF	OF	OF	GS	GS	OF	OF	OF	EL	EL	GS	EL	EL	EL	EL	EL	EL	EL	EL	EL	EL	EL	EL	EL	EL	EL	EL	EL	EL	EL	EL	
	DS	HI	HI	HI	HI	HI	HI	HI	HI	HI	HI	HI	HI	HI	HI	HI	HI	HI	HI	HI	HI	HI	HI	HI	HI	HI	HI	HI	HI	HI	HI	HI	HI	HI	HI	HI	HI	
	ST	5	5	5	5	5	5	5	5	5	5	5	5	5	5	5	5	5	5	5	5	5	5	5	5	5	5	5	5	5	5	5	5	5	5	5	5	
	DP	0	0	0	0	0	0	0	0	0	0	0	0	0	0	0	0	0	0	0	0	0	0	0	0	0	0	0	0	0	0	0	0	0	0	0	0	0
	DN	1	1	1	1	1	1	1	1	1	1	1	1	1	1	1	1	1	5	1	1	1	1	1	1	1	1	1	1	1	1	1	1	1	1	1	1	
	DD	SP	SP	SP	SP	SP	SP	SP	SP	SP	SP	SP	SP	SP	SP	SP	SP	SP	SP	SP	SP	SP	SP	SP	SP	SP	SP	SP	SP	SP	SP	SP	SP	SP	SP	SP	SP	
	DH	3	3	3	3	3	3	3	3	3	3	3	3	3	3	3	3	3	3	3	3	3	3	3	3	3	3	3	3	3	3	3	3	3	3	3	3	
	FD	YS	YS	YS	YS	YS	YS	YS	YS	NO	YS	YS	YS	YS	NO	NO	NO	NO	NO	NO	NO	NO	NO	NO	NO	NO	NO	NO	NO	NO	NO	NO	NO	NO	NO	NO	NO	
	FR	5	5	5	5	5	5	5	5	5	5	5	5	5	5	5	5	5	5	5	5	5	5	5	5	5	5	5	5	5	5	5	5	5	5	5		
	FS	3	3	3	3	3	3	3	3	3	3	3	3	3	3	3	3	3	3	3	3	3	3	3	3	3	3	3	3	3	3	3	3	3	3	3	3	
	FM	TM	TM	TM	TM	TM	TM	TM	NO	TM	TM	TM	TM	TM	TM	TM	TM	TM	NO	TM	TM	TM	TM	TM	TM	TM	TM	TM	TM	TM	TM	TM	TM	TM	TM	TM	TM	

Individual EcoPro G2 Cabinets Parameter Values



Version	1	2	3	4	5	6	7	8	9	10	12	13	14	16	17	18	19	20	21	23	24	25	26	28	29	31	32	33	34	35	36	37	38	39	
LM	NO	NO	MN	MN	MN	NO	NO	NO	NO	NO	NO	NO	NO	NO	NO	NO	NO	NO	NO	NO	NO	NO	NO	NO	NO	NO	NO	NO	NO	NO	NO	NO	NO	NO	
R2	EF	NO	EF	EF	EF	EF	EF	EF	EF	EF	EF	EF	EF	EF	EF	EF	EF	EF	EF	EF	EF	EF	EF	EF	EF	EF	EF	EF	EF	EF	EF	EF	EF	EF	
R3	NO	NO	LM	LM	LM	NO	NO	NO	DF	NO	NO	NO	NO	DF	DF	DF	DF	DF	DF	DF	DF	DF	DF	DF	DF	DF	DF	DF	DF	DF	DF	DF	DF	DF	
R4	NO	NO	NO	NO	NO	NO	NO	NO	01	NO	NO	NO	NO	01	01	01	01	01	01	01	01	01	01	01	01	01	01	01	01	01	01	01	01	01	
O1	0	0	0	0	0	0	0	0	0	0	0	0	0	0	0	0	0	0	0	0	0	0	0	0	0	0	0	0	0	0	0	0	0	0	
T2	NO	NO	NO	NO	NO	NO	NO	NO	YS	NO	NO	NO	NO	YS	YS	YS	YS	YS	YS	YS	YS	YS	YS	YS	YS	YS	YS	YS	YS	NO	NO	NO	NO	YS	
O2	0	0	0	0	0	0	0	0	0	0	0	0	0	0	0	0	0	0	0	0	0	0	0	0	0	0	0	0	0	0	0	0	0	0	0
SC	2C	2C	2C	2C	2C	2C	2C	2C	2C	2C	2C	2C	2C	2C	2C	2C	2C	2C	2C	2C	2C	2C	2C	2C	2C	2C	2C	2C	2C	2C	2C	2C	2C	2C	2C
SM	5	5	5	5	5	5	5	5	5	5	5	5	5	5	5	5	5	5	5	5	5	5	5	5	5	5	5	5	5	5	5	5	5	5	
AR	1	1	1	1	1	1	1	1	1	1	1	1	1	1	1	1	1	1	1	1	1	1	1	1	1	1	1	1	1	1	1	1	1	1	

Technical Data EcoPro G2 Cabinets – EP models

Cabinet Models	Gas	Hertz	Gas Charge	Compressor	Capillary	Defrost Type	Power Consumption		Fuse Rating
							Watts	Amps	
EP700H & EP700H2	R134a	50	265 grms	EMT6160Z	0.042" ID x 0.93" OD x 3.5m	Timed Off Cycle	262	1.8	10 Amp
	R134a	60	TBC	NEK6160Z	0.042" ID x 0.93" OD x 3.5m	Timed Off Cycle	TBC	TBC	10 Amp
	R290	50	95 grms	EMT6144U	0.042" ID x 0.93" OD x 3.5m	Timed Off Cycle	TBC	TBC	10 Amp
	R404	50	TBC	TBC	TBC	Timed Off Cycle	262	1.8	10 Amp
EP700L & EP700L2	R404	50	275 grms	NEK2168GK	0.047" ID x 0.085" OD x 2.5m	Hot Gas	548	3.7	10 Amp
	R404	60	TBC	NT2168GK	0.047" ID x 0.085" OD x 2.5m	Hot Gas	TBC	TBC	10 Amp
	R290	50	120 grms	NEK2150U	0.042" ID x 0.93" OD x 3.5m	Hot Gas	TBC	TBC	10 Amp
	R134	50	TBC	TBC	TBC	Hot Gas	548	3.7	10 Amp
EP700M & EP700M2	R134a	50	265 grms	EMT6160Z	0.042" ID x 0.93" OD x 3.5m	Hot Gas	262	1.8	10 Amp
	R134a	60	TBC	NEK6160Z	0.042" ID x 0.93" OD x 3.5m	Hot Gas	TBC	TBC	10 Amp
	R290	50	95 grms	EMT6144U	0.042" ID x 0.93" OD x 3.5m	Hot Gas	TBC	TBC	10 Amp
	R134a	50	TBC	EMT6160Z	0.042" ID x 0.93" OD x 3.5m	TBC	310	2.0	10 Amp
EP700G	R290	50	TBC	EMT6144U	0.042" ID x 0.93" OD x 3.5m	TBC	TBC	TBC	10 Amp
	R134a	50	TBC	EMT6160Z	0.042" ID x 0.93" OD x 3.5m	TBC	310	2.0	10 Amp
EP700W	R290	50	95 grms	EMT6144U	0.042" ID x 0.93" OD x 3.5m	TBC	TBC	TBC	10 Amp
	R134a	50	340 grms	NEK6214Z	0.054" Bore x 22 SWG x 3.0m	Timed Off Cycle	611	4.4	10 Amp
EP1440H & EP1440H4	R134a	60	TBC	NEK6214Z	0.054" Bore x 22 SWG x 3.0m	Timed Off Cycle	TBC	TBC	10 Amp
	R404	50	TBC	TBC	0.054" Bore x 22 SWG x 3.0m	Timed Off Cycle	611	4.4	10 Amp
	R290	50	150 grms	NEK6213U	0.054" Bore x 22 SWG x 3.0m	Timed Off Cycle	TBC	TBC	10 Amp
	R404	50	610 grms	NT2192GK	0.047" Bore x 22 SWG x 4.0m	Hot Gas	734/ 611	3.7/ 4.4	10 Amp
EP1440L & EP1440L4	R404	60	TBC	NT2192GK	0.047" Bore x 22 SWG x 4.0m	Hot Gas	TBC	TBC	10 Amp
	R290	50	135 grms	NT2180U	0.047" Bore x 22 SWG x 4.0m	Hot Gas	TBC	TBC	10 Amp
	R134a	50	340 grms	NEK6214Z	0.054" Bore x 22 SWG x 3.0m	Hot Gas	611/ 734	4.4/ 3.7	10 Amp
	R134a	60	TBC	NEK6214Z	0.054" Bore x 22 SWG x 3.0m	Hot Gas	TBC	TBC	10 Amp
EP1440M & EP1440M4	R404	50	TBC	TBC	TBC	Hot Gas	611/ 734	4.4/ 3.7	10 Amp
	R290	50	150 grms	NEK6213U	0.054" Bore x 22 SWG x 3.0m	Hot Gas	TBC	TBC	10 Amp
	R134a	50	TBC	NEK6214Z	0.054" Bore x 22 SWG x 3.0m	TBC	611	4.4	10 Amp
	R290	50	TBC	NEK6213U	0.054" Bore x 22 SWG x 3.0m	TBC	TBC	TBC	10 Amp
EP1440G	R134a	50	340 grms	NEK6214Z	0.054" Bore x 22 SWG x 3.0m	TBC	611/ 734	4.4/ 3.7	10 Amp
	R290	50	TBC	TBC	TBC	TBC	611	4.4	10 Amp
	R134a	50	340 grms	NEK6214Z	0.054" Bore x 22 SWG x 3.0m	TBC	711	4.8	10 Amp
	R290	50	TBC	NEK6213U	0.054" Bore x 22 SWG x 3.0m	TBC	TBC	TBC	10 Amp
EP700 & 1440 HU	TBC	TBC	TBC	TBC	Timed Off Cycle	TBC	TBC	10 Amp	
EP700 & 1440 MU	TBC	TBC	TBC	TBC	Electric	TBC	TBC	10 Amp	
EP700 & 1440 LU	TBC	TBC	TBC	TBC	Electric	TBC	TBC	10 Amp	



Cabinet Models	Gas	Hertz	Gas Charge	Compressor	Capillary	Defrost Type	Power Consumption		Fuse Rating
							Watts	Amps	
G700H	R134A	50	265 grms	EMT6160Z	0.042" ID x 0.93" OD x 3.5m	Timed Off Cycle	TBC	TBC	10 Amp
	R290	50	95 grms	EMT6144U	0.042" ID x 0.93" OD x 3.5m	Timed Off Cycle	TBC	TBC	10 Amp
G700L	R404	50	TBC	NEK2168GK	0.047" ID x 0.085" OD x 2.5m	Hot Gas	TBC	TBC	10 Amp
	R290	50	120 grms	NEK2150U	0.042" ID x 0.93" OD x 3.0m	Hot Gas	TBC	TBC	10 Amp
G700M	R134a	50	TBC	EMT6160Z	0.042" ID x 0.93" OD x 3.5m	Hot Gas	TBC	TBC	10 Amp
	R290	50	95 grms	EMT6144U	0.042" ID x 0.93" OD x 3.5m	Hot Gas	TBC	TBC	10 Amp
G1440H	R134a	50	340 grms	NEK6214Z	0.054" Bore x 22 SWG x 3.0m	Timed Off Cycle	TBC	TBC	10 Amp
	R290	50	150 grms	NEK6213U	0.054" Bore x 22 SWG x 3.0m	Timed Off Cycle	TBC	TBC	10 Amp
G1440L	R404	50	TBC	NT2192GK	0.047" Bore x 22 SWG x 4.0m	Hot Gas	TBC	TBC	10 Amp
	R290	50	135 grms	NT2180U	0.047" Bore x 22 SWG x 4.0m	Hot Gas	TBC	TBC	10 Amp
G1440M	R134a	50	TBC	NEK6214Z	0.054" Bore x 22 SWG x 3.0m	Hot Gas	TBC	TBC	10 Amp
	R290	50	150 grms	NEK6213U	0.054" Bore x 22 SWG x 3.0m	Hot Gas	TBC	TBC	10 Amp

Note: The Power Consumption values referred to as tested are to the ECA test standard. Actual power consumption will be greatly affected by ambient temperature, loading, usage and cabinet maintenance.

Wiring Diagram for High, Wine and Fish Temperature Cabinets

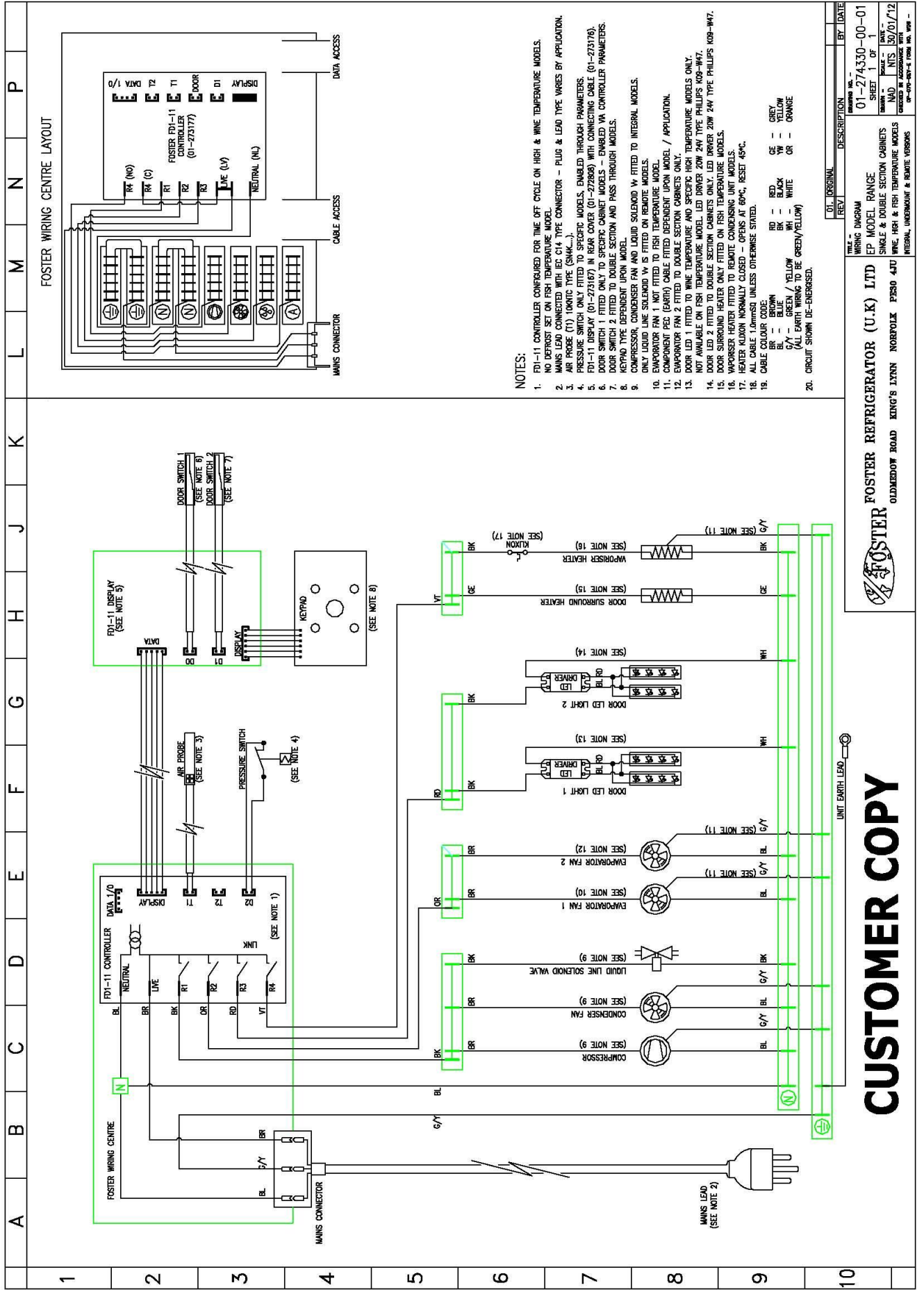

- NOTES:**
- FD1-11 CONTROLLER CONFIGURED FOR TIME OFF CYCLE ON HIGH & WINE TEMPERATURE MODELS.
 - NO DETROST SET ON FISH TEMPERATURE MODEL.
 - MAINS LEAD CONNECTED WITH EC C14 TYPE CONNECTOR - PLUG & LEAD TYPE VARIES BY APPLICATION.
 - AIR PROBE (TI) LIMITIC TYPE (SNK...).
 - PRESSURE SWITCH ONLY FITTED TO SPECIFIC MODELS. ENABLED THROUGH PARAMETERS.
 - FD1-11 DISPLAY (01-273167) IN REAR COVER (01-272806) WITH CONNECTING CABLE (01-273176).
 - DOOR SWITCH 1 FITTED TO SPECIFIC CABINET MODELS - ENABLED VIA CONTROLLER PARAMETERS.
 - DOOR SWITCH 2 FITTED TO DOUBLE SECTION AND PASS THROUGH MODELS.
 - KEYPAD TYPE DEPENDENT UPON MODEL.
 - COMPRESSOR, CONDENSER FAN AND LIQUID SOLENOID VV FITTED TO INTEGRAL MODELS.
 - ONLY LIQUID LINE SOLENOID VV IS FITTED ON REMOTE MODELS.
 - EVAPORATOR FAN 1 NOT FITTED TO FISH TEMPERATURE MODEL.
 - COMPONENT PEC (EARTH) CABLE FITTED DEPENDENT UPON MODEL / APPLICATION.
 - EVAPORATOR FAN 2 FITTED TO DOUBLE SECTION CABINETS ONLY.
 - DOOR LED 1 FITTED TO WINE TEMPERATURE AND SPECIFIC HIGH TEMPERATURE MODELS ONLY.
 - DOOR LED 2 FITTED TO DOUBLE SECTION CABINETS ONLY. LED DRIVER 20W 24V TYPE PHILLIPS K09-W47.
 - DOOR SURROUND HEATER ONLY FITTED ON FISH TEMPERATURE MODELS.
 - VAPORISER HEATER FITTED TO REMOTE CONDENSING UNIT MODELS.
 - HEATER KUXON NORMALLY CLOSED - OPENS AT 60°C, RESET 45°C.
 - ALL CABLE 1.0mm² UNLESS OTHERWISE STATED.
 - CABLE COLOUR CODE:
 - RD - RED
 - BR - BLACK
 - GE - GREY
 - BL - BLUE
 - WH - WHITE
 - OR - ORANGE
 - GY - GREEN / YELLOW
 - GY - GREEN / YELLOW (ALL EARTH WIRING TO BE GREEN/YELLOW)
 - CIRCUIT SHOWN DE-ENERGISED.

GT	ORIGINAL	DESCRIPTION	BY	DATE
		WIRING DIAGRAM		
PART NO. 01-274330-00-01		SHEET 1 OF 1		
EP MODEL RANGE		SINGLE & DOUBLE SECTION CABINETS		
MAD NTS 30/01/12		WINE, HIGH & FISH TEMPERATURE MODELS		
EP-010-01-01-01		INTEGRAL, UNDERMOUNT & REMOTE VERSIONS		

FOSTER REFRIGERATOR (U.K) LTD
 KING'S LYNN NOBROUX PERSO 43U
 OLDMEADOW ROAD KING'S LYNN NOBROUX PERSO 43U
 FOSTER

CUSTOMER COPY

Wiring Diagram for Low and Meat Temperature Cabinets

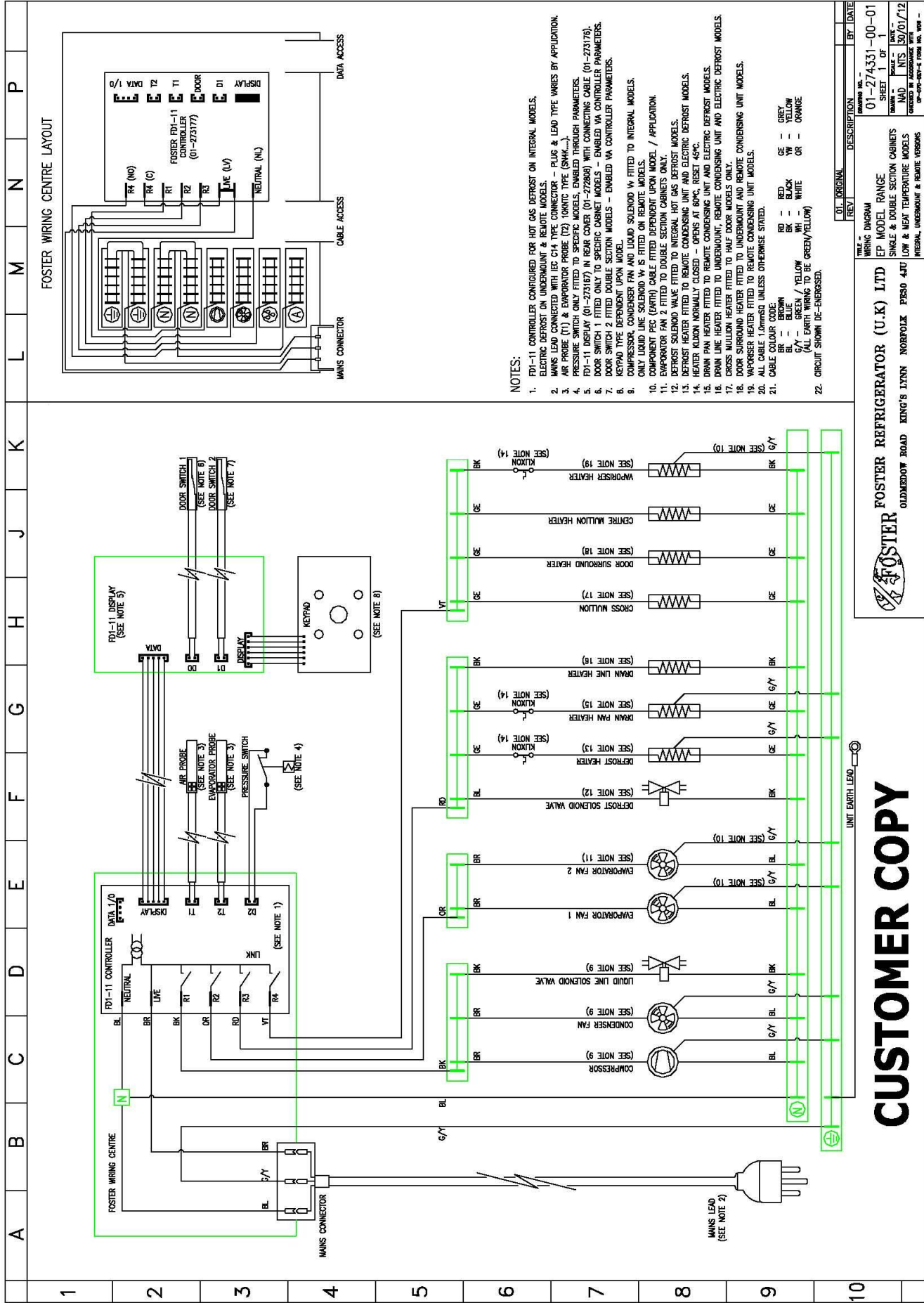

REV	DESCRIPTION	BY	DATE
01	ORIGINAL		

WIRING DIAGRAM
EP MODEL RANGE
 SINGLE & DOUBLE SECTION CABINETS
 LOW & MEAT TEMPERATURE MODELS
 INTERNAL UNDERMOUNT & REMOTE VERSIONS

SHEET 11 OF 11
 DRAWN NTS 30/01/12
 CHECKED M ASSOCIATE WITH
 01-274331-00-01

FOSTER
 KING'S LYNN NOBOROLIX PERSO 43U
 OLDREDWOOD ROAD

FOSTER REFRIGERATOR (U.K) LTD
 FOSTER REFRIGERATOR (U.K) LTD

CUSTOMER COPY

Air and Evaporator Probe Details / Diagram

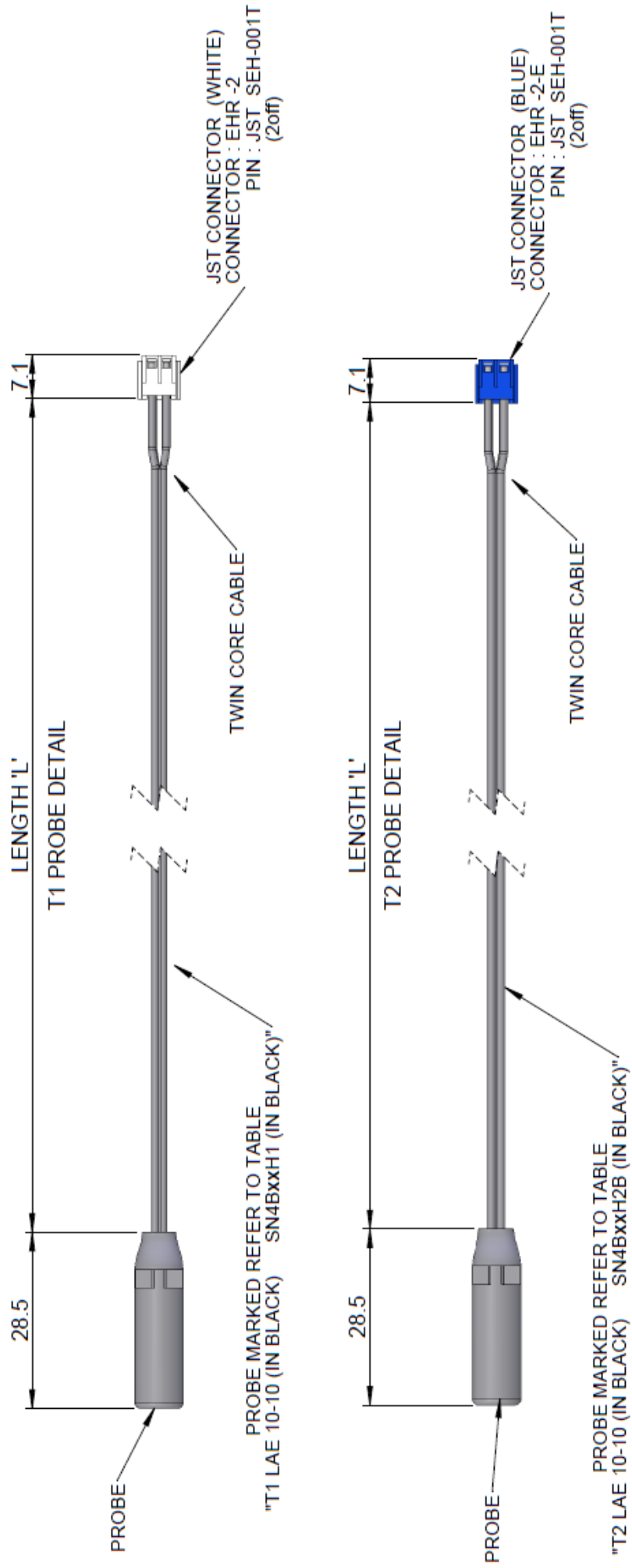



Individual EcoPro G2 Counters Parameter Values

FD2-11 Default		1	2	3	4	5	6	7	8	9	10	11	12	13	14	15	16	17	18	19	20	21	22	23	24
Version	Par	1	2	3	4	5	6	7	8	9	10	11	12	13	14	15	16	17	18	19	20	21	22	23	24
SL	1	1	1	1	-21	-21	-2	-2	1	1	1	1	-21	-21	-2	-2	1	1	1	-21	-21	-2	-2	1	1
SH	3	3	3	-19	-19	8	8	1	1	1	1	1	-21	-21	-2	-2	3	3	3	-21	-21	-2	-2	3	3
SP	1.5	1.5	1.5	-21	-21	-1.5	-1.5	1.5	1.5	1.5	1.5	1.5	-21	-21	-1.5	-1.5	1.5	1.5	1.5	-21	-21	-1.5	-1.5	1.5	1.5
CH	RF	RF	RF	RF	RF	RF	RF	RF	RF	RF	RF	RF	RF	RF	RF	RF	RF	RF	RF	RF	RF	RF	RF	RF	RF
HY	3	3	3	3	3	3	3	3	3	3	3	3	3	3	3	3	3	3	3	3	3	3	3	3	3
CR	2	2	2	2	2	2	2	2	2	2	2	2	2	2	2	2	2	2	2	2	2	2	2	2	2
C1	6	6	6	6	6	6	6	6	6	6	6	6	6	6	6	6	6	6	6	6	6	6	6	6	6
C2	4	4	4	4	4	4	4	4	4	4	4	4	4	4	4	4	4	4	4	4	4	4	4	4	4
CS	1	1	1	1	1	1	1	1	1	1	1	1	1	1	1	1	1	1	1	1	1	1	1	1	1
DM	TM	TM	TM	TM	TM	TM	TM	TM	TM	TM	TM	TM	TM	TM	TM	TM	TM	TM	TM	TM	TM	TM	TM	TM	TM
DB	6	6	6	6	6	6	6	6	6	6	6	6	6	6	6	6	6	6	6	6	6	6	6	6	6
DF	YS	YS	YS	YS	YS	YS	YS	YS	YS	YS	YS	YS	YS	YS	YS	YS	YS	YS	YS	YS	YS	YS	YS	YS	YS
DL	15	15	15	15	15	15	15	15	15	15	15	15	15	15	15	15	15	15	15	15	15	15	15	15	15
DT	20	20	20	20	20	20	20	20	20	20	20	20	20	20	20	20	20	20	20	20	20	20	20	20	20
DY	OF	OF	OF	GS	EL	EL	GS	EL	OF	OF	OF	OF	GS	EL	GS	EL	OF	OF	OF	GS	EL	GS	EL	OF	OF
DS	HI	HI	HI	HI	HI	HI	HI	HI	HI	HI	HI	HI	HI	HI	HI	HI	HI	HI	HI	HI	HI	HI	HI	HI	HI
ST	5	5	5	5	5	5	5	5	5	5	5	5	5	5	5	5	5	5	5	5	5	5	5	5	5
DP	0	0	0	0	0	0	0	0	0	0	0	0	0	0	0	0	0	0	0	0	0	0	0	0	0
DR	3	3	3	3	3	3	3	3	3	3	3	3	3	3	3	3	3	3	3	3	3	3	3	3	3
DN	1	1	1	1	1	1	1	1	1	1	1	1	1	1	1	1	1	1	1	1	1	1	1	1	1
DD	SP	SP	SP	SP	SP	SP	SP	SP	SP	SP	SP	SP	SP	SP	SP	SP	SP	SP	SP	SP	SP	SP	SP	SP	SP
DH	3	3	3	6	6	3	3	3	3	3	3	3	6	6	3	3	3	3	3	6	6	3	3	3	3
FD	YS	YS	YS	NO	NO	NO	NO	NO	YS	YS	YS	YS	NO	NO	NO	NO	YS	YS	YS	NO	NO	NO	NO	NO	YS
FR	5	5	5	-5	-5	5	5	5	5	5	5	5	-5	-5	5	5	5	5	5	-5	-5	5	5	5	5
FS	3	3	3	3	3	3	3	3	3	3	3	3	3	3	3	3	3	3	3	3	3	3	3	3	3

Individual EcoPro G2 Counters Parameter Values



Version	1	2	3	4	5	6	7	8	9	10	11	12	13	14	15	16	17	18	19	20	21	22	23	24
Par																								
FM	TM	NO	NO	NO	NO	NO	NO	NO	NO	NO	NO	NO	NO	NO	NO	NO	NO	NO	NO	NO	NO	NO	NO	NO
FT	-1	-1	-1	-1	-1	-1	-1	-1	-1	-1	-1	-1	-1	-1	-1	-1	-1	-1	-1	-1	-1	-1	-1	-1
FH	3	3	3	3	3	3	3	3	3	3	3	3	3	3	3	3	3	3	3	3	3	3	3	3
F1	10	10	10	10	10	10	10	10	10	10	10	10	10	10	10	10	10	10	10	10	10	10	10	10
F2	60	60	60	60	60	60	60	60	60	60	60	60	60	60	60	60	60	60	60	60	60	60	60	60
F3	30	30	30	30	30	30	30	30	30	30	30	30	30	30	30	30	30	30	30	30	30	30	30	30
FP	20	20	20	20	20	20	20	20	20	20	20	20	20	20	20	20	20	20	20	20	20	20	20	20
AT	RL	RL	RL	RL	RL	RL	RL	RL	RL	RL	RL	RL	RL	RL	RL	RL	RL	RL	RL	RL	RL	RL	RL	RL
AL	-3	-3	-3	-3	-3	-3	-3	-3	-3	-3	-3	-3	-3	-3	-3	-3	-3	-3	-3	-3	-3	-3	-3	-3
AH	8	8	8	8	8	8	8	8	8	8	8	8	8	8	8	8	8	8	8	8	8	8	8	8
LD	-5	-5	-5	-5	-5	-5	-5	-5	-5	-5	-5	-5	-5	-5	-5	-5	-5	-5	-5	-5	-5	-5	-5	-5
HD	5	5	5	5	5	5	5	5	5	5	5	5	5	5	5	5	5	5	5	5	5	5	5	5
AI	T1	T1	T1	T1	T1	T1	T1	T1	T1	T1	T1	T1	T1	T1	T1	T1	T1	T1	T1	T1	T1	T1	T1	T1
AD	90	90	90	90	90	90	90	90	90	90	90	90	90	90	90	90	90	90	90	90	90	90	90	90
AO	5	5	5	5	5	5	5	5	5	5	5	5	5	5	5	5	5	5	5	5	5	5	5	5
PF	10	10	10	10	10	10	10	10	10	10	10	10	10	10	10	10	10	10	10	10	10	10	10	10
AM	NO	NO	NO	NO	NO	NO	NO	NO	NO	NO	NO	NO	NO	NO	NO	NO	NO	NO	NO	NO	NO	NO	NO	NO
AS	65	65	65	65	65	65	65	65	65	65	65	65	65	65	65	65	65	65	65	65	65	65	65	65
AF	ST	ST	ST	ST	ST	ST	ST	ST	ST	ST	ST	ST	ST	ST	ST	ST	ST	ST	ST	ST	ST	ST	ST	ST
AC	0	0	0	0	0	0	0	0	0	0	0	0	0	0	0	0	0	0	0	0	0	0	0	0
IIM	AU	NO	NO	NO	NO	NO	NO	NO	NO	NO	NO	NO	NO	NO	NO	NO	NO	NO	NO	NO	NO	NO	NO	NO
IIS	20	20	20	20	20	20	20	20	20	20	20	20	20	20	20	20	20	20	20	20	20	20	20	20
IIT	6	6	6	6	6	6	6	6	6	6	6	6	6	6	6	6	6	6	6	6	6	6	6	6
IIP	2	2	2	2	2	2	2	2	2	2	2	2	2	2	2	2	2	2	2	2	2	2	2	2
IYY	3	3	3	3	3	3	3	3	3	3	3	3	3	3	3	3	3	3	3	3	3	3	3	3
IIF	TM	TM	TM	TM	TM	TM	TM	TM	TM	TM	TM	TM	TM	TM	TM	TM	TM	TM	TM	TM	TM	TM	TM	TM
IID	12	12	12	12	12	12	12	12	12	12	12	12	12	12	12	12	12	12	12	12	12	12	12	12
IIE	LT	LT	LT	LT	LT	LT	LT	LT	LT	LT	LT	LT	LT	LT	LT	LT	LT	LT	LT	LT	LT	LT	LT	LT
DC	NO	NO	NO	NO	NO	NO	NO	NO	NO	NO	NO	NO	NO	NO	NO	NO	NO	NO	NO	NO	NO	NO	NO	NO
SB	YS	YS	YS	YS	YS	YS	YS	YS	YS	YS	YS	YS	YS	YS	YS	YS	YS	YS	YS	YS	YS	YS	YS	YS
D0	DS	NO	NO	NO	NO	NO	NO	NO	NO	NO	NO	NO	NO	NO	NO	NO	NO	NO	NO	NO	NO	NO	NO	NO
D1	NO	NO	NO	NO	NO	NO	NO	NO	NO	NO	NO	NO	NO	NO	NO	NO	NO	NO	NO	NO	NO	NO	NO	NO
D2	NO	NO	NO	NO	NO	NO	NO	NO	NO	NO	NO	NO	NO	NO	NO	NO	NO	NO	NO	NO	NO	NO	NO	NO

Individual EcoPro G2 Counters Parameter Values

Version	1	2	3	4	5	6	7	8	9	10	11	12	13	14	15	16	17	18	19	20	21	22	23	24
Par																								
T3	DP	DP	DP	DP	DP	DP	DP	DP	DP	DP	DP	DP	DP	DP	DP	DP	DP	DP	DP	DP	DP	DP	DP	DP
O3	0	0	0	0	0	0	0	0	0	0	0	0	0	0	0	0	0	0	0	0	0	0	0	0
LM	NO	NO	NO	NO	NO	NO	NO	MN	NO	NO	NO	NO	NO	NO	NO	MN	NO	NO	NO	NO	NO	NO	NO	NO
R2	EF	EF	EF	EF	EF	EF	EF	EF	EF	EF	EF	EF	EF	EF	EF	EF	EF	EF	EF	EF	EF	EF	EF	EF
R3	NO	NO	NO	NO	NO	NO	NO	LM	NO	NO	NO	NO	NO	NO	NO	LM	NO	NO	NO	NO	NO	NO	NO	NO
R4	NO	NO	NO	NO	NO	NO	NO	NO	NO	NO	NO	NO	NO	NO	NO	NO	NO	NO	NO	NO	NO	NO	NO	NO
O1	0	0	0	0	0	0	0	0	0	0	0	0	0	0	0	0	0	0	0	0	0	0	0	0
T2	NO	NO	NO	NO	NO	NO	NO	NO	NO	NO	NO	NO	NO	NO	NO	NO	NO	NO	NO	NO	NO	NO	NO	NO
O2	0	0	0	0	0	0	0	0	0	0	0	0	0	0	0	0	0	0	0	0	0	0	0	0
SC	2C	2C	2C	2C	2C	2C	2C	2C	2C	2C	2C	2C	2C	2C	2C	2C	2C	2C	2C	2C	2C	2C	2C	2C
SM	5	5	5	5	5	5	5	5	5	5	5	5	5	5	5	5	5	5	5	5	5	5	5	5
AR	1	1	1	1	1	1	1	1	1	1	1	1	1	1	1	1	1	1	1	1	1	1	1	1

Wiring Diagram for High Temperature Counters



ABCDEFGHJKLMNP

FOSTER WIRING CENTRE (00-566467) / UID (01-266727-02)

DATA ACCESS

CABLE ACCESS

DATA ACCESS

NOTES:

- FID-11 CONTROLLER COMBINED FOR THE 6FT CYCLE DEFROST
- MAINS LEAD CONNECTED WITH EC C14 TYPE CONNECTOR - PLUS A LEAD THE WIRES BY APPLICATION.
- MR PROBE (T1) TORQUE TYPE (254K...)
- FID-11 DISPLAY (01-273166) IN REAR COVER (01-273808) WITH CONNECTING CABLE (01-274799).
- COMPRESSOR, CONDENSER FAN FITTED ONLY TO MEDICAL MODELS.
- UNION LINE SOLIDWAVE IS FITTED TO BOTH MEDICAL AND REMOTE MODELS.
- COMMON LINE (GDPH) CABLE FITTED DEPENDANT UPON MODEL / APPLICATION.
- LED LIGHTS FITTED AS OPTION ONLY COMPARISON:
 EP1/2 MODELS: 1 x PSU 01-55247-01, AND 1 x LED FITTING 01-55263-01.
 EP1/3 MODELS: 1 x PSU 01-55248-01, AND 2 x LED FITTINGS 01-55263-01
 EP1/4 MODELS: 1 x PSU 01-55247-01, 1 x PSU 01-55248-01 AND 3 x LED FITTINGS 01-55263-01.
- DOOR SURROUND HEATER OPTIONAL, FIT ON SPECIFIC MODELS, CABLE COLOURS VARY BY MODEL.
- WARMER HEATER FITTED TO REMOTE CONCEALING UNIT MODELS.
- HEATER AUTOM NORMALLY CLOSED - OPENS AT 40%.
- ALL CABLE 1AWMS20 UNLESS OTHERWISE STATED.
- CABLE COLOUR CODE:
 BR - BROWN
 BK - BLACK
 G/Y - GREEN / YELLOW
 W - WHITE
 OR - ORANGE
 GY - GREY
 YE - YELLOW
 BL - BLUE
 GR - GREEN
 WH - WHITE
 OR - ORANGE
- CIRCUIT SHOWN UN-ENERGISED.

EP - 62' COUNTER RANGE
 HIGH TEMPERATURE MODELS

REV	DESCRIPTION	DATE	BY	CHKD
01	LIGHT OPTION CHANGE (ECR2723)			

FOSTER REFRIGERATOR (U.K) LTD
 GARDENWAY ROAD KING'S LYNN NORFOLK PE30 4JU

CUSTOMER COPY

Wiring Diagram for Low and Meat Temperature Counters

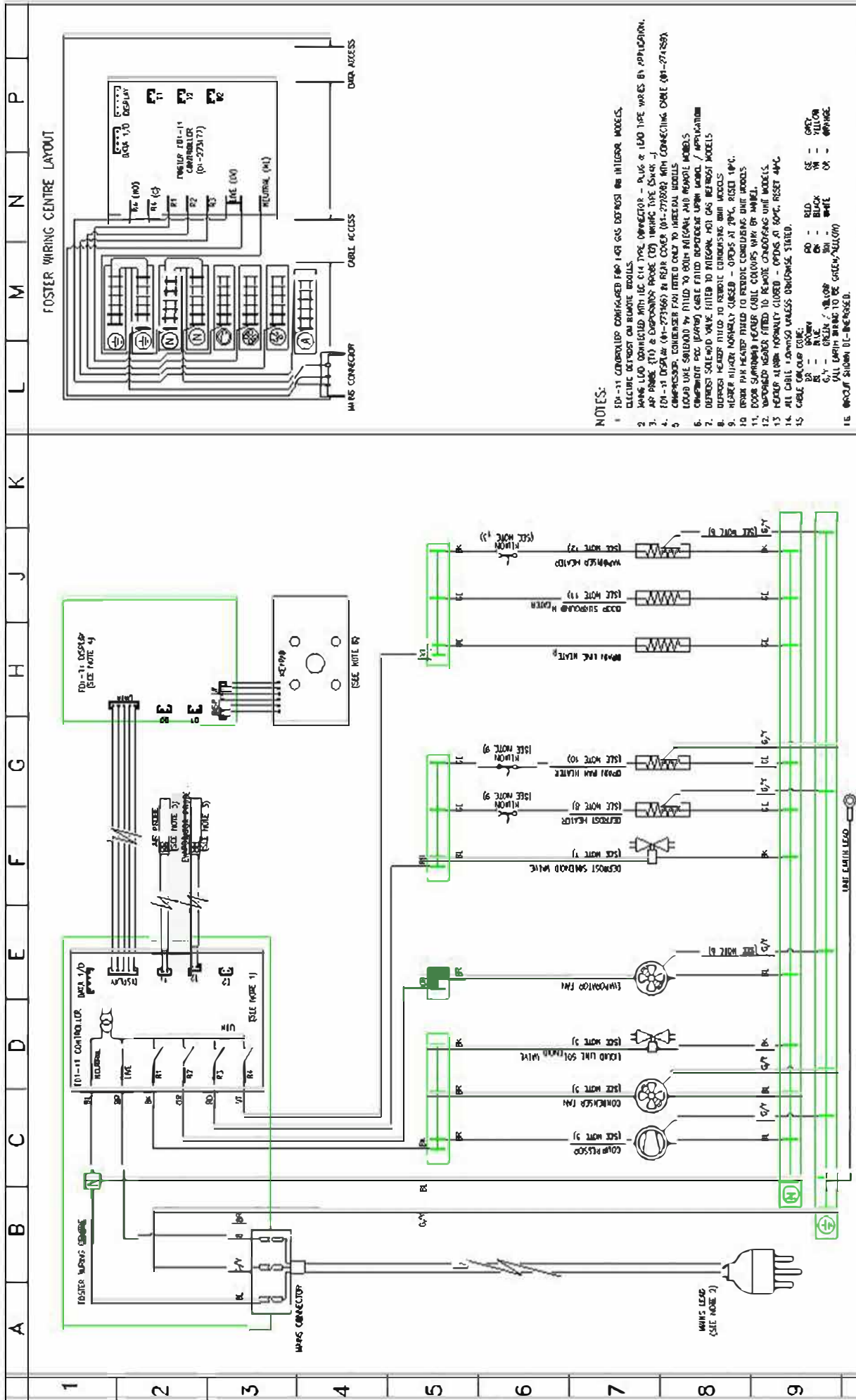

FOSTER WIRING CENTRE LAYOUT

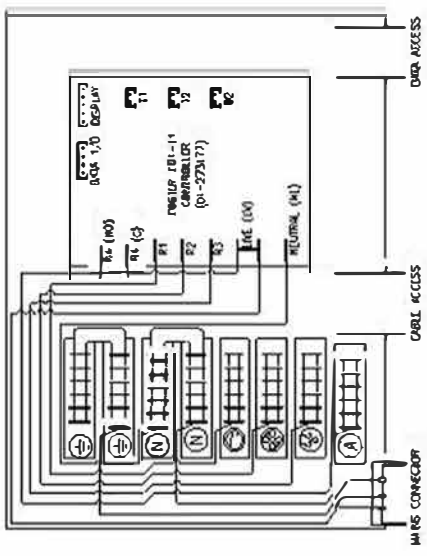

NOTES:

1. 101-11 CONTROLLER CONFIGURED FOR GAS DEFROST ON INTERIOR MODELS.
2. ALL WIRING MUST BE DONE IN ACCORDANCE WITH THE I.E.E. WIRING REGULATIONS.
3. WIRING LEAD CONNECTED WITH THE 6.14 TYPE CONNECTOR - PLUS & LEAD TYPE WIRES BY APPLICATION.
4. ALL WIRING TO BE DONE IN ACCORDANCE WITH THE I.E.E. WIRING REGULATIONS.
5. 101-11 DISPLAY (41-273146) BY REAR COVER (41-273182) WITH CONNECTING CABLE (41-271258).
6. COMPRESSOR CURRENTS FOR THIS UNIT TO BE TAKEN FROM MAIN SUPPLY.
7. LEAD WIRE SUPPLIED BY FOSTER TO BE USED TO CONNECT MAIN SUPPLY TO APPLICATION.
8. DEFROST HEATER MUST BE FITTED TO INTERIOR MODELS.
9. DEFROST HEATER NORMALLY CLOSED - OPENS AT 40°C. RESET 40°C.
10. DEFROST HEATER MUST BE FITTED TO EXTERIOR COMPRESSOR UNIT MODELS.
11. DEFROST HEATER NORMALLY CLOSED - OPENS AT 40°C. RESET 40°C.
12. DEFROST HEATER NORMALLY CLOSED - OPENS AT 40°C. RESET 40°C.
13. DEFROST HEATER NORMALLY CLOSED - OPENS AT 40°C. RESET 40°C.
14. ALL CABLE CONNECTIONS UNLESS OTHERWISE STATED.
15. CABLE END CAPS TO BE USED.
16. ALL CABLE CONNECTIONS UNLESS OTHERWISE STATED.
17. ALL CABLE CONNECTIONS UNLESS OTHERWISE STATED.
18. ALL CABLE CONNECTIONS UNLESS OTHERWISE STATED.
19. ALL CABLE CONNECTIONS UNLESS OTHERWISE STATED.
20. ALL CABLE CONNECTIONS UNLESS OTHERWISE STATED.
21. ALL CABLE CONNECTIONS UNLESS OTHERWISE STATED.
22. ALL CABLE CONNECTIONS UNLESS OTHERWISE STATED.
23. ALL CABLE CONNECTIONS UNLESS OTHERWISE STATED.
24. ALL CABLE CONNECTIONS UNLESS OTHERWISE STATED.
25. ALL CABLE CONNECTIONS UNLESS OTHERWISE STATED.
26. ALL CABLE CONNECTIONS UNLESS OTHERWISE STATED.
27. ALL CABLE CONNECTIONS UNLESS OTHERWISE STATED.
28. ALL CABLE CONNECTIONS UNLESS OTHERWISE STATED.
29. ALL CABLE CONNECTIONS UNLESS OTHERWISE STATED.
30. ALL CABLE CONNECTIONS UNLESS OTHERWISE STATED.
31. ALL CABLE CONNECTIONS UNLESS OTHERWISE STATED.
32. ALL CABLE CONNECTIONS UNLESS OTHERWISE STATED.
33. ALL CABLE CONNECTIONS UNLESS OTHERWISE STATED.
34. ALL CABLE CONNECTIONS UNLESS OTHERWISE STATED.
35. ALL CABLE CONNECTIONS UNLESS OTHERWISE STATED.
36. ALL CABLE CONNECTIONS UNLESS OTHERWISE STATED.
37. ALL CABLE CONNECTIONS UNLESS OTHERWISE STATED.
38. ALL CABLE CONNECTIONS UNLESS OTHERWISE STATED.
39. ALL CABLE CONNECTIONS UNLESS OTHERWISE STATED.
40. ALL CABLE CONNECTIONS UNLESS OTHERWISE STATED.
41. ALL CABLE CONNECTIONS UNLESS OTHERWISE STATED.
42. ALL CABLE CONNECTIONS UNLESS OTHERWISE STATED.
43. ALL CABLE CONNECTIONS UNLESS OTHERWISE STATED.
44. ALL CABLE CONNECTIONS UNLESS OTHERWISE STATED.
45. ALL CABLE CONNECTIONS UNLESS OTHERWISE STATED.
46. ALL CABLE CONNECTIONS UNLESS OTHERWISE STATED.
47. ALL CABLE CONNECTIONS UNLESS OTHERWISE STATED.
48. ALL CABLE CONNECTIONS UNLESS OTHERWISE STATED.
49. ALL CABLE CONNECTIONS UNLESS OTHERWISE STATED.
50. ALL CABLE CONNECTIONS UNLESS OTHERWISE STATED.
51. ALL CABLE CONNECTIONS UNLESS OTHERWISE STATED.
52. ALL CABLE CONNECTIONS UNLESS OTHERWISE STATED.
53. ALL CABLE CONNECTIONS UNLESS OTHERWISE STATED.
54. ALL CABLE CONNECTIONS UNLESS OTHERWISE STATED.
55. ALL CABLE CONNECTIONS UNLESS OTHERWISE STATED.
56. ALL CABLE CONNECTIONS UNLESS OTHERWISE STATED.
57. ALL CABLE CONNECTIONS UNLESS OTHERWISE STATED.
58. ALL CABLE CONNECTIONS UNLESS OTHERWISE STATED.
59. ALL CABLE CONNECTIONS UNLESS OTHERWISE STATED.
60. ALL CABLE CONNECTIONS UNLESS OTHERWISE STATED.
61. ALL CABLE CONNECTIONS UNLESS OTHERWISE STATED.
62. ALL CABLE CONNECTIONS UNLESS OTHERWISE STATED.
63. ALL CABLE CONNECTIONS UNLESS OTHERWISE STATED.
64. ALL CABLE CONNECTIONS UNLESS OTHERWISE STATED.
65. ALL CABLE CONNECTIONS UNLESS OTHERWISE STATED.
66. ALL CABLE CONNECTIONS UNLESS OTHERWISE STATED.
67. ALL CABLE CONNECTIONS UNLESS OTHERWISE STATED.
68. ALL CABLE CONNECTIONS UNLESS OTHERWISE STATED.
69. ALL CABLE CONNECTIONS UNLESS OTHERWISE STATED.
70. ALL CABLE CONNECTIONS UNLESS OTHERWISE STATED.
71. ALL CABLE CONNECTIONS UNLESS OTHERWISE STATED.
72. ALL CABLE CONNECTIONS UNLESS OTHERWISE STATED.
73. ALL CABLE CONNECTIONS UNLESS OTHERWISE STATED.
74. ALL CABLE CONNECTIONS UNLESS OTHERWISE STATED.
75. ALL CABLE CONNECTIONS UNLESS OTHERWISE STATED.
76. ALL CABLE CONNECTIONS UNLESS OTHERWISE STATED.
77. ALL CABLE CONNECTIONS UNLESS OTHERWISE STATED.
78. ALL CABLE CONNECTIONS UNLESS OTHERWISE STATED.
79. ALL CABLE CONNECTIONS UNLESS OTHERWISE STATED.
80. ALL CABLE CONNECTIONS UNLESS OTHERWISE STATED.
81. ALL CABLE CONNECTIONS UNLESS OTHERWISE STATED.
82. ALL CABLE CONNECTIONS UNLESS OTHERWISE STATED.
83. ALL CABLE CONNECTIONS UNLESS OTHERWISE STATED.
84. ALL CABLE CONNECTIONS UNLESS OTHERWISE STATED.
85. ALL CABLE CONNECTIONS UNLESS OTHERWISE STATED.
86. ALL CABLE CONNECTIONS UNLESS OTHERWISE STATED.
87. ALL CABLE CONNECTIONS UNLESS OTHERWISE STATED.
88. ALL CABLE CONNECTIONS UNLESS OTHERWISE STATED.
89. ALL CABLE CONNECTIONS UNLESS OTHERWISE STATED.
90. ALL CABLE CONNECTIONS UNLESS OTHERWISE STATED.
91. ALL CABLE CONNECTIONS UNLESS OTHERWISE STATED.
92. ALL CABLE CONNECTIONS UNLESS OTHERWISE STATED.
93. ALL CABLE CONNECTIONS UNLESS OTHERWISE STATED.
94. ALL CABLE CONNECTIONS UNLESS OTHERWISE STATED.
95. ALL CABLE CONNECTIONS UNLESS OTHERWISE STATED.
96. ALL CABLE CONNECTIONS UNLESS OTHERWISE STATED.
97. ALL CABLE CONNECTIONS UNLESS OTHERWISE STATED.
98. ALL CABLE CONNECTIONS UNLESS OTHERWISE STATED.
99. ALL CABLE CONNECTIONS UNLESS OTHERWISE STATED.
100. ALL CABLE CONNECTIONS UNLESS OTHERWISE STATED.

REV.	DESCRIPTION	DATE
01	ISSUE	01-275214-00-01
02	ISSUE	01-275214-00-01
03	ISSUE	01-275214-00-01
04	ISSUE	01-275214-00-01
05	ISSUE	01-275214-00-01
06	ISSUE	01-275214-00-01
07	ISSUE	01-275214-00-01
08	ISSUE	01-275214-00-01
09	ISSUE	01-275214-00-01
10	ISSUE	01-275214-00-01







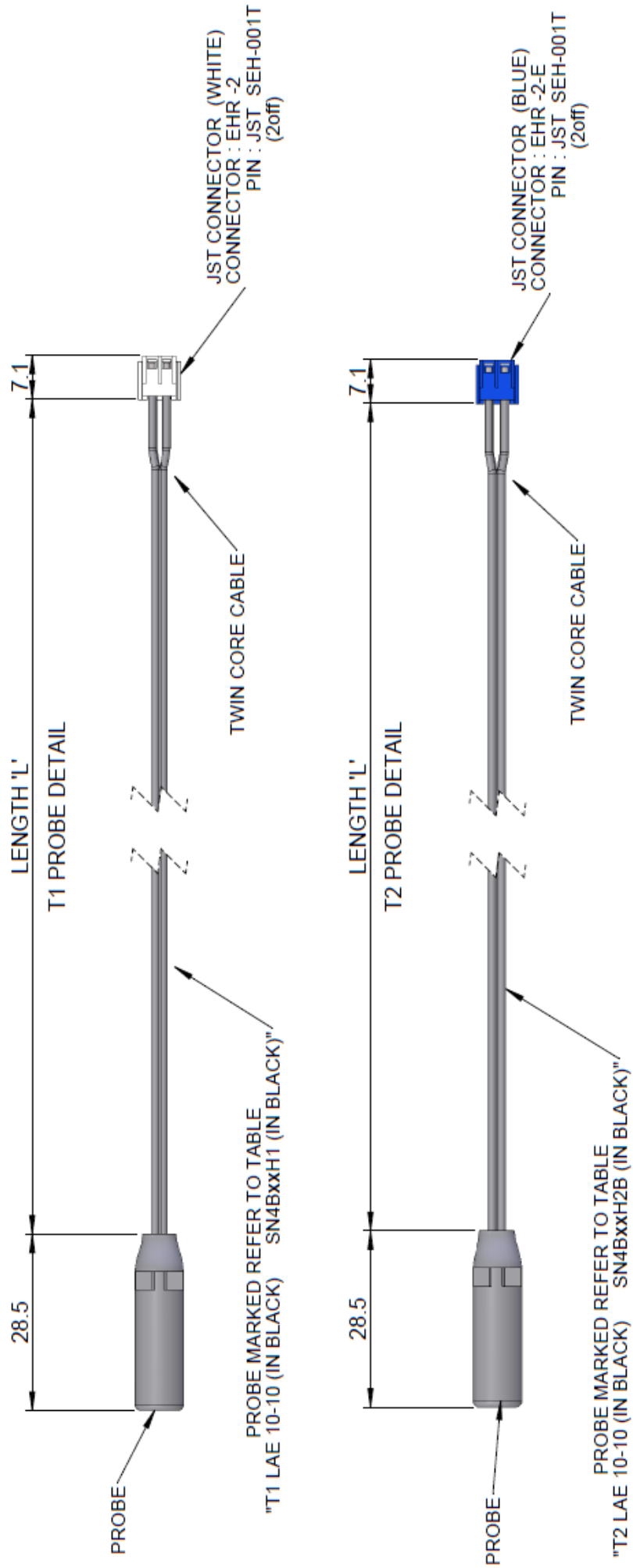







CUSTOMER COPY

FOSTER REFRIGERATOR (U.K.) LTD
 OLDFIELD ROAD KING'S LYNN NORFOLK PE30 4JU
 TEL: 01493 810000 FAX: 01493 810001

Air and Evaporator Probe Details / Diagram



Troubleshooting

Problem	Possible Cause	Solution
Audible & Visual Alarms/Warnings	<ul style="list-style-type: none">  > Low temperature alarm  > High temperature alarm  > T1 Air probe failure  > T2 Evaporator probe failure[#]  > T3 Condenser probe failure[#]  > Condenser clean warning[#]  > Condenser high temperature alarm[#]  > High pressure alarm[#]  > Door open alarm[#]  > Mains power failure[#] 	<ul style="list-style-type: none"> > Cancel audible alarm and investigate cause. > Cancel audible alarm and investigate cause. > Check and replace the air probe > Check and replace the evaporator probe > Check and replace the condenser probe. > Carry out cleaning regime on the condenser. The timer is reset when power is removed and reset. > Clean condenser and ensure ambient temperature is not too high. > Check ambient temperature and refrigeration system. > Press  to silence alarm and close the door. If the alarm persists and the door is closed check and replace the door switches. >  will be displayed, the alarm will sound and  will show when there has been a mains power failure that has affected the internal air temperature of the cabinet (only if the unit was not in standby mode). When mains power is restored the cabinet will continue to operate, and adjust the temperature as required. The warning will sound & show  until  has been pressed and released, to cancel the alarm. We would recommend the contents of the unit are inspected.
<i>[#] only displayed if applicable to model and enabled through parameters</i>		
Compressor will not start	<ul style="list-style-type: none"> > No voltage in socket > Electrical conductor or wires may be cut > Defective electrical component: thermostat, relay, thermal protector etc. 	<ul style="list-style-type: none"> > Use voltmeter to check > Use ohmmeter to check for continuity > Replace defective component





- > Compressor motor has a winding open or shorted
- > Compressor stuck
- > Temperature control contacts are open
- > Incorrect wiring
- > Fuse blown or circuit breaker tripped.
- > Power cord unplugged
- > Controller set too high
- > Cabinet in defrost cycle
- > Measure ohmic resistance of main and auxiliary winding using ohmmeter. Compare with correct values
- > Change compressor
- > Repair or replace the contacts
- > Check wiring diagram and correct
- > Replace fuse or reset circuit breaker
- > Plug in power cord.
- > Set controller to lower temperature.
- > Wait for defrost cycle to finish







The temperature is too cold

- > Controller is set at a very cold position
- > Controller does not disconnect the condensing unit
- > Control contacts are stuck closed
- > Defective or incorrect temperature control
- > Set to warmer position and check if the compressor stops according to controllers operating range.
- > Check the insulation of the thermostat. If problem persists, change the thermostat
- > Change the control. Check amperage load
- > Determine correct control and replace.

The temperature is not cold enough



- > Controller is set at a very warm position
- > Condenser is dirty
- > The refrigerator has been placed at an inadequate location
- > Compressor is inefficient or there is a high pressure due to the air in the system
- > Iced up evaporator coil
- > Restriction in system
- > The refrigerator has been used improperly
- > Adjust to colder setting
- > Clean condenser
- > The unit must not be near stoves, walls that are exposed to the sun, or places that lack sufficient air flow.
- > If there is air in the system, purge and recharge
- > Check temperature control, refrigerant charge, and defrost mechanism. Remove all ice manually and start over.
- > Locate exact point of restriction and correct
- > The shelves must never be covered with any type of plastic or other material that will block the circulation of cold air within the refrigerator.

- 
 - > Too many door openings
- 
 - > Excessive heat load placed in cabinet
- 
 - > The refrigerator has been overcharged with the refrigerant gas
- 
 - > The refrigerant gas is leaking
- 
 - > The evaporator and/or condenser fans are not working
- 
 - > Blocking air flow
- > Fuse blown or circuit breaker tripped
- > Advise user to decrease if possible
 - > Advise user not to put in products that are too hot.
 - > Check to see if condensation or ice crystals have formed on the suction line. If so, charge with the correct amount of gas.
 - > Find the location of gas leak in order to seal and replace the defective component. Change the drier. Perform a good vacuum and recharge unit.
 - > Check electrical connections and make sure that the fan blade isn't stuck. Replace the fan motor if it doesn't work.
 - > Re-arrange product to allow for proper air flow. Make sure there is at least four inches of clearance from evaporator.
 - > Replace fuse or reset circuit breaker.

Electrical Shocks



- > Wires or electrical components are in direct contact with metallic parts.
- > Check for appropriate insulation on the connections of each component.

Noise



- > The refrigerator is not properly levelled
- > The condenser is not fastened correctly. Copper tubing is in contact with metal
- > The evaporator and/or condenser fans are loose
- > Compressor has an internal noise
- > Loose part(s)
- > Check if the noise goes away after you level the refrigerator
- > While the compressor is working, check to see if metal parts are in contact with one another and/or if the screws that fasten the condenser are tightened.
- > Check if the fans are securely fastened. Also, check if the fan blades are loose, broken or crooked. If so, change the faulty blade.
- > If the noise persists after all other measures have been taken, it may be originating from the compressor.
- > Locate and tighten loose part(s)

Extreme condensation inside the refrigerator

- > Controller is set at a very cold position
- > The outside environment's relative humidity is very high (over 75%)
- > The refrigerator door won't shut completely
- > The refrigerator had been placed at an inadequate location
- > Set the controller to a warmer position & check to see if compressor stops as should.
- > This type of occurrence is caused by local climatic conditions and not by the refrigeration unit.
- > Check the door and/or the magnetic gasket. Adjust the door hinges if needed; replace the gasket if broken.
- > The unit must not be near sources that produce too much heat.

Condensing unit runs for long periods of time



- > Excessive amount of warm product placed in cabinet
- > Advise user to leave adequate time for products to cool down



- > Prolonged door opening or door ajar
- > Advise user to ensure doors are closed when not in use and to avoid opening doors for long periods of time.



- > Door gasket(s) not sealing properly
- > Ensure gaskets are snapped in completely. Remove gasket and wash with soap and water. Check condition of gasket & replace if necessary
- > Clean condenser coil



- > Dirty condenser coil
- > Dirty condenser coil
- > Evaporator coil iced over
- > Unplug unit and allow coil to defrost. Make sure thermostat is not set too cold. Ensure that door gasket(s) are sealing properly. Select manual defrost and ensure system works.

Notes



Foster European Operations

France

Foster Refrigerator France SA

Tel: (33) 01 34 30 22 22. Fax: (33) 01 30 37 68 74.

Email: info@foster-fr.com

Germany

Foster Refrigerator GmbH,

Tel: (49) 781 990 7840. Fax (49) 781 990 7844.

Email: info@foster-gmbh.de

Foster Refrigerator

Oldmedow Road

Kings Lynn

Norfolk

PE30 4JU

Tel: 0843 216 8833

Fax: 0843 216 4707

Website: www.fosterrefrigerator.co.uk

Email: support@foster-uk.com

a Division of 'ITW (UK) Ltd'

ECOPROG2 CAB FD1-11/SM 03/12 GB