



# EPro Cabinets & Counters with FD2-10 Controller



# Service Manual



ISO 14001



ISO 9001



Re-Issued April 2011

## Contents









Manual Information & Health & Safety Notes	1
Environmental Management Policy	2
Disposal Requirements	2
EPro Cabinet & Counter Description	3
Controller Relevance Table & Operation	3 to 4
User Functions	4 to 5
Defrost Operation & Fuzzy Logic	5
Wiring Diagram for Defrost & Technical Data	6
Configuration of Parameters	6
Controller Default	7 to 10
Individual Unit Controller Parameter Values	11 to 14
Technical Data	15 to 16
Wiring Diagrams & Probe details	17 to 19
Troubleshooting & Notes	20 to 22

### Service Manual Information

The products and all information in this manual are subject to change without prior notice. We assume by the information given that the person(s) working on these refrigeration units are fully trained and skilled in all aspects of their workings. Also that they will use the appropriate safety equipment and take or meet precautions where required.

The service manual does not cover information on every variation of this unit; neither does it cover the installation or every possible operating or maintenance instruction for the units.

### Health & Safety Warnings and Information

	Make sure the power supply is turned off before making any electrical repairs.
	To minimise shock and fire hazards, please do not plug or unplug the unit with wet hands.
	During maintenance and cleaning, please unplug the unit where required.
	Care must be taken when handling or working on the unit as sharp edges may cause personal injury, we recommend the wearing of suitable PPE.
	Ensure the correct moving and lifting procedures are used when relocating a unit.
	Do NOT use abrasive cleaning products, only those that are recommended. Never scour any parts of the refrigerator. Scouring pads or chemicals may cause damage by scratching or dulling polished surface finishes.
	Failure to keep the condenser clean may cause premature failure of the motor/compressor which will NOT be covered under warranty policy.
	Do NOT touch the cold surfaces in the freezer compartment. Particularly when hands are damp or wet, skin may adhere to these extremely cold surfaces and cause frostbite.
	Please ensure the appropriate use of safety aids or Personnel Protective Equipment (PPE) are used for you own safety.

## **Environmental Management Policy for Service Manuals and Duets.**

### **Product Support and Installation Contractors**

Foster Refrigerator recognises that its activities, products and services can have an adverse impact upon the environment.

The organisation is committed to implementing systems and controls to manage, reduce and eliminate its adverse environmental impacts wherever possible, and has formulated an Environmental Policy outlining our core aims. A copy of the Environmental Policy is available to all contractors and suppliers upon request.

The organisation is committed to working with suppliers and contractors where their activities have the potential to impact upon the environment. To achieve the aims stated in the Environmental Policy we require that all suppliers and contractors operate in compliance with the law and are committed to best practice in environmental management.

Product Support and Installation contractors are required to:

1. Ensure that wherever possible waste is removed from the client's site, where arrangements are in place all waste should be returned to Foster Refrigerator's premises. In certain circumstances waste may be disposed of on the client's site; if permission is given, if the client has arrangements in place for the type of waste.
2. If arranging for the disposal of your waste, handle, store and dispose of it in such a way as to prevent its escape into the environment, harm to human health, and to ensure the compliance with the environmental law. Guidance is available from the Environment Agency on how to comply with the waste management 'duty of care'.
3. The following waste must be stored of separately from other wastes, as they are hazardous to the environment: refrigerants, polyurethane foam, and oils.
4. When arranging for disposal of waste, ensure a waste transfer note or consignment note is completed as appropriate. Ensure that all waste is correctly described on the waste note and include the appropriate six-digit code from the European Waste Catalogue. Your waste contractor or Foster can provide further information if necessary.
5. Ensure that all waste is removed by a registered waste carrier, a carrier in possession of a waste management licence, or a carrier holding an appropriate exemption. Ensure the person receiving the waste at its ultimate destination is in receipt of a waste management licence or valid exemption.
6. Handle and store refrigerants in such a way as to prevent their emission to atmosphere, and ensure they are disposed of safely and in accordance with environmental law.
7. Make arrangements to ensure all staff who handle refrigerants do so at a level of competence consistent with the City Guilds 2078 Handling Refrigerants qualification or equivalent qualification.
8. Ensure all liquid substances are securely stored to prevent leaks and spill, and are **not** disposed of to storm drains, foul drain, or surface water to soil.

### **Disposal Requirements**

If not disposed of properly all refrigerators have components that can be harmful to the environment. All old refrigerators must be disposed of by appropriately registered and licensed waste contractors, and in accordance with national laws and regulations.

## EPro Cabinet and Counter Description

The EPro range comes in two formats, the Full Gastronorm and the Non-Gastronorm.

Both come with a choice of capacities and temperatures, the full format comes with 650x530 shelves whereas the Non-Gastronorm unit has a smaller shelf measuring 530x550. The EPro range also features Bakery models fitted with racking to take 30"x18" trays as standard but can be modified to take 60x40cm trays when ordered. (Specially built units will have the prefix 'C').

The units are manufactured as a one piece shell with easy clean stainless steel exterior. Each conforms to the current legislation and exceeds the Montreal protocol by using zero ODP (ozone depleting substances) refrigerants and insulation. There is also the added option of having Hydrocarbon refrigerant.

Each unit's temperature is controlled by a microprocessor with digital temperature display. There are several temperature options available exceeding the Climate Class 5 operations by giving an ambient temperature to 43°C. Each temperature display is also easy to read with a wipe clean finish.

The standard form of refrigeration system in this unit is integrated with an air-cooled condensing unit that allows cooled air to circulate through the evaporator, via the fan into storage areas. It does this by distributing the refrigerant into the evaporator controlled by a capillary.

Remote systems are also available as an option, the difference being, the evaporator is controlled by an expansion valve instead of capillary.

Other points to be made on these units are that they have coated coils to prevent corrosion and to help prolong the refrigerator's life. They have easily removable thermal breaks, giving easy access to the door frame heater while also having a wide magnetic gasket that gives a positive door seal.

Cabinets come with an easily removable plug box and lid, while counters have an easy access condensing unit fitted on the side to make servicing that much easier.

## Controller Relavance Table

Model	1 <sup>st</sup> Serial Number Issued	Manufacturer Date from	Model	1 <sup>st</sup> Serial Number Issued	Manufacturer Date from
<b>Cabinets</b>			<b>Counters</b>		
500	E5270978	13.09.2010	1/2, 1/3, 1/4, 2/2, 2/3	E5262849	01.06.2010
600	E5266862	19.07.2010	Duel Temp	E5275227	01.11.2010
1350	E5264326	05.07.2010	EPROG600HU, LU & MU	E5275295	04.10.2010

## Controller Operation

FD2-10 Controller (00-556302)

Probe Air 2.5M SN4B15H1 (00-556284)

LCD 5S Display (00-555992)

Probe Evap 2.5M SNBK15H2 (00-556287)



LCD 5S Display (00-555992)

## Indicators and Buttons

Symbol	Reason	Button	Use
	Alarm		Info / Set Point Button
	Thermostat Output		Manual Defrost / Decrease Button
	Fan Output		Increase Button / Manual Activation
	Defrost Output		Stand-by Button
	Activation of 2 <sup>nd</sup> parameter set		

## Display

During normal operation the display shows either the temperature measured or one of the following indicators:

Symbol	Reason	Symbol	Reason
dEF	Defrost in progress	hP	Condenser high pressure alarm
aFF	Controller in stand-by	h <sub>1</sub>	Room high temperature alarm
cl	Condenser clean warning	Lo	Room low temperature alarm
do	Door open alarm	E1	Probe T1 failure
hc	Condenser high temperature alarm	E2	Probe T2 failure

## Information Menu

The information available in the menu is shown below:

Symbol	Reason	Symbol	Reason
t1	Instant probe 1 temperature	tLo	Minimum probe 1 temperature recorded
t2	Instant probe 2 temperature *	cnd	Compressor working weeks **
t3	Instant probe 3 temperature *	Loc	Keypad state lock
th <sub>1</sub>	Maximum probe 1 temperature recorded		

\* Displayed only if enabled (see configuration parameters)

\*\* Displayed only if ACC > 0

## User Functions

### Start Sequence

For normal operation

- Press and hold the  button for 3 seconds then release.

If pressed and held for 5 seconds then released this will start the 'Test Sequence'.





The test function is a defined sequence of events that will follow a prescribed pattern (dependent upon parameter values) that will operate all electrical elements of the system, simulating a short operating pattern. This was designed to provide a quick simple evaluation tool either during manufacturing or service.

### To cancel the Test Sequence





- Press and release the  button during the test sequence.

If not pressed the test will continue and when complete the controller will wait for 1 min, then resume normal operation. (The controller will count to 530 then show 'end'. It will then show the current unit temperature)





### Access to the menu and information displayed

- Press and immediately release button 
- With button  or  select the data to be displayed
- Press button  to display the value
- To exit from the menu, press button  or wait for 10 seconds.



### Set point: Display and modification

- Press button  for at least half a second to display the set point.
- By keeping button  pressed, use button  or  to set the desired value (adjustment is within the minimum SPL and the maximum SPH limit)
- When button  is released, the new value is stored.

## Reset of THI, TLO, CND recordings

- With button  or  select the data to be reset
- Display the value with button 
- While keeping button  pressed, use button .

## Standby

When pressing the  button for 3 seconds, will allow the controller to be put on a standby or output control to be resumed (with SB = YES only). When on Standby  will be displayed.

## Selection of second parameter group

It is possible to select control parameters between two different pre-programmed groups, in order for the fundamental control parameters to be adapted to changing needs. Changeover from Group I to Group II (and visa versa) may take place **Manually** by pressing  for 2 seconds (with IISM = MAN), or **Automatically** when heavy duty conditions are detected (with IISM = HDD), or when IISM =D12 and the **Auxiliary Input D12** is activated (the activation of D12 selects Group II). If IISM = NON, switchover to Group II is inhibited. The activation of Group II is signalled by the lighting up of relevant LED on the controller display.

## Defrost

### Automatic Defrost.

Defrost starts automatically as soon as the time set with parameter DFT has elapsed.

- **Time Defrost** With DFM = TIM defrost takes place at regular intervals when the timer reaches the value DFT. For example, with DFM = TIM and DFT = 06, a defrost will take place every 6 hours.
- **Defrost time count backup** At the power-up, if DFB = YES, the defrost timer resumes the time count from where it was left off before the power interruption. Visa versa with DFB=NO, the time count re-starts from 0. In stand-by the accumulated time count is frozen.

### Defrost type

Once defrost has started, compressor and defrost outputs are controlled according to parameter DTY. If FID =YES, the evaporator fans are active during defrost.

### Resuming Thermostatic Cycle

When defrost is over, if DRN is greater then 0, all outputs will remain off the DRN minutes, in order for the ice to melt completely and the resulting water to drain.

### Manual Defrost

To initiate a manual defrost press and hold the defrost button  for 2 seconds.

## Fuzzy Logic

'Fuzzy Logic' is an energy saving feature which enables the refrigeration system performance on specific models to be automatically adjusted during operation, for optimum energy performance whilst maintaining the correct internal storage temperature. When enabled it works by identifying periods of high and low usage and applying an appropriate temperature set point and defrost frequency. Additionally the evaporator fan(s) can be caused to cycle (providing 'air stir' only) in low usage periods.

'Fuzzy Logic' operation is controlled by parameter 'IISM'. Setting the value 'HDD' for this parameter will cause the controller to automatically change between the 'economy' and 'performance' operating modes (the actual switching point sensitivity is controlled by parameter 'HDS'). Setting 'IISM' to 'non' will disable the 'Fuzzy Logic' function. When enabled, and upon the product being switched 'On', 'Fuzzy Logic' will automatically start using the 'economy' settings to control the operation of the temperature and defrost ('SP', 'HYS', and 'DFT'). The controller will remain operating to the values of these settings unless; through monitoring of the air temperature, evaporator temperature and door switch (where T2 probe and door switch are fitted), the controller determines that the usage frequency or temperature variation indicates more demanding operational conditions. In such circumstances the controller will switch to the 'performance' mode (utilising parameters 'IISP', 'IIHY' and 'IIDF').

Upon usage or temperature variation reducing sufficiently the controller will revert back to the 'economy mode'. The evaporator fan operation works in conjunction with, but separate from 'Fuzzy Logic'. Determined by parameter 'FCM', and normally set to 'TIM', the fans will run continuously when the compressor is on, subject to the door switch operation (where fitted). During the compressor off cycle the fans will operate in an 'air stir' mode (controlled by parameters 'FT1', 'FT2' and 'FT3'). Where 'FCM' is set to 'non' the fans will run continuously. The fan cycle mode during the 'performance' operation of 'Fuzzy Logic' is controlled by parameter 'IIFC'.

# Parameter Setting Wiring Diagram for Synchronising Defrost Start and Termination

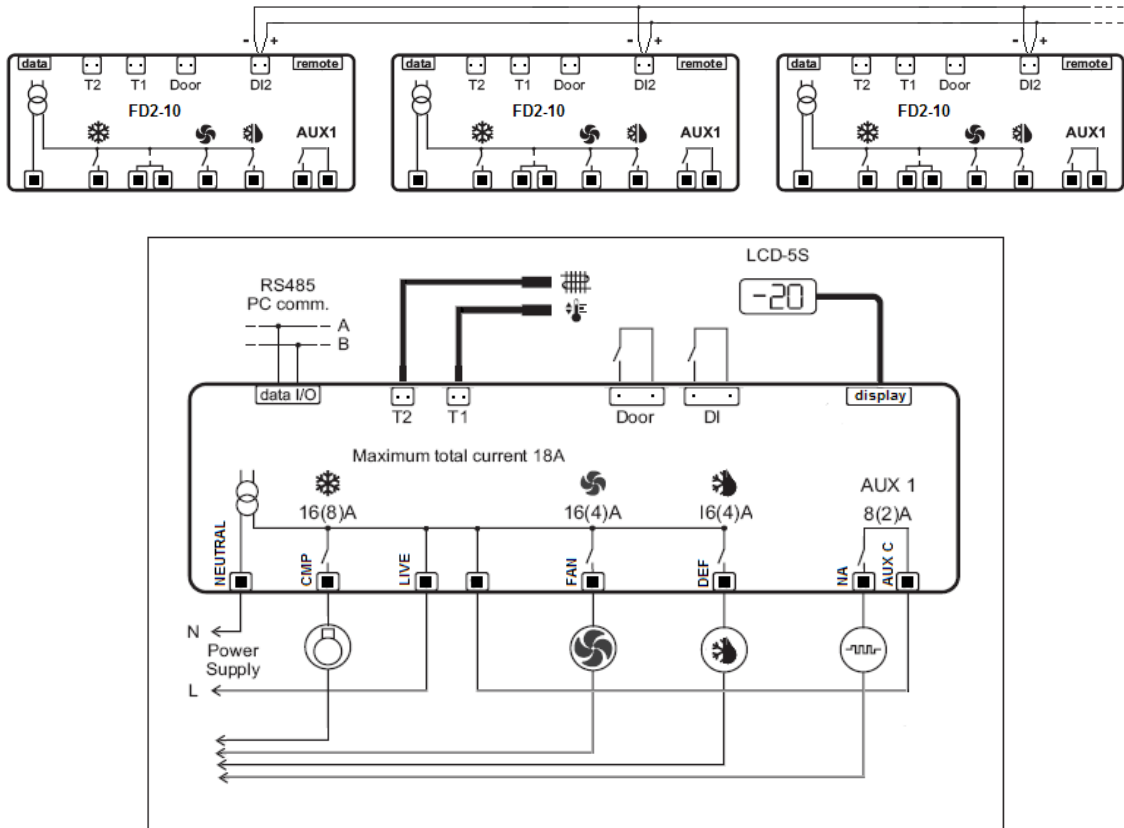

## Technical Data

### Power Supply

FD2-10 230Vac±10%, 50/60Hz, 3W

### Relay Output

Compressor 16(8) A 240Vac  
 Defrost 16(4) A 240Vac  
 Evap. Fan 16(4) A 240Vac  
 Auxiliary Loads 1 8(2) A 240Vac

### Input

NTC 10KΩ@25°C

### Measurement Range

-50...120°C, -55...240°F  
 -50 / -9.9...19.9 / 80°C (NTC 10K Only)

### Measurement Accuracy

<0.5°C within the measurement range

### CE (Reference norms)

EN60730-1; EN60730-2-9  
 EN55022 (Class B)  
 EN50082-1

## Configuration Parameters



- To get access to the parameter configuration menu, press + for 5 seconds
- With button or select the parameter to be modified.
- Press button and hold briefly to display the value. On releasing the button the controller will then show the next parameter.
- By keeping button pressed, use button or to set the desired value. On releasing the button the controller will store the amended value and then show the next parameter.
- To exit from the setup, press button or wait for 30 seconds.

## EPro Controller Default Parameter Values

Parameter	Range	Description	Foster FD2-10
SCL		<b>Readout Scale:</b>	2°C
	1°C	Range -50/-9.9.... 19.9/80°C (With INP = SN4 Only)	
	2°C	Range -50 .... 120°C	
	°F	Range -55 .... 240°F	
SPL	-50 ... SPH	Minimum Limit for SP setting	1
SPH	SPL ... 120°	Maximum limit for SP setting	3
SP	SPL ... SPH	Temperature set point to be achieved	2
C-H		<b>Temperature Control mode:</b>	REF
	REF	Refrigeration	
	HEA	Heating	
HYS	1 ... 10°	Off/On Thermostat differential	3
CRT	0 ... 30min	Compressor Rest Time	2
CT1	0 ... 30min	Thermostat run time with faulty T1 (CT1 = 0 output with faulty T1 will always be off)	6
CT2	0 ... 30min	Thermostat off time with faulty T1 probe. (CT2=0 & CT1 = >0 output with faulty T1 will always be on)	4
CSD	0 ... 30min	Compressor stop delay after door has been opened (Only if DS – YES)	1
DFM		<b>Defrost Start Mode:</b>	TIM
	Non	Defrost function is disabled	
	TIM	Regular time defrost	
	FRO	Defrost time elapses only in condition of frost accumulation	
DFT	0...99 Hours	Time interval between defrosts	6
DFB		<b>Defrost timer clock</b>	YES
	YES	Following mains interruption, timer resumes count	
	NO	Following mains interruption, timer restarts from zero	
DLI	-50.. 120°	Defrost end temperature (Only if T2 = EPO)	N/A
DTO	1 ... 120min	Maximum defrost duration	20
DTY		<b>Defrost Type:</b>	OFF
	OFF	Timed off cycle defrost (compressor and heater off)	
	ELE	Electric heater defrost (compressor off, heater on)	
	GAS	Hot gas defrost (compressor and heater on)	
DPD	0 ... 240 sec	Evaporator pump down. Timed pause at start of defrost	0
DRN	0 ... 30min	Drain down period	2
DDM		<b>Defrost display mode:</b>	DEF
	RT	Real (actual) air temperature	
	LT	Last temperature display before start of defrost	
	SP	The current set point value.	
	DEF	"DEF"	



DDY	0... 60 min	Defrost display delay period Time DDM is shown following defrost termination	10
FID		<b>Fans in defrost:</b>	YES
	YES	Fans run during defrost	
	NO	Fans do not run during defrost	
FDD	-50 ... 120°	Evaporator fan restart temperature following defrost (Only if T2 = EPO)	5
FTO	0... 120 min	Maximum evaporator fan stop period following defrost	3
FDS	0... 120 sec	Minimum evaporator fan stops (following door opening etc)	20
FCM		<b>Evaporator fan mode during thermostatic control:</b>	TIM
	NON	Fan(s) run continuously	
	TMP	Temperature based control. When compressor is on, fans are on. When compressor is off, fans run as long as temperature difference $T_e - T_a > FD$ . Fans on again with FDH	
	Tim	Time based control. When compressor is on, fans are on. When compressor is off, fans in accordance to parameters FT1, FT2 and FT3.	
FDT	-120 ... 0°	$T_e - T_a$ difference for fans to turn off after compressor stopped. (Only if T2 = EPO and FCM = TMP)	-1
FDH	1 ... 120°	Temperature differential for evaporator fan restart. (Only if T2 = EPO and FCM = TMP)	3
FT1	0 ... 180 Sec	Fan stop delay after compressor stop.	15
FT2	0 ... 30min	Timed fan stop following T1 (With FT2 = 0 the fans remain on all the time).	3
FT3	0 .. 30min	Timed fan run following FT2 (With FT3 = 0 and FT2 >0 the fans remain off all the time.	2
ATM		<b>Alarm threshold configuration:</b>	REL
	NON	All temperature alarms are inhibited	
	ABS	The value set in ALA and AHA represent actual alarm set points	
	REL	The values set in ALR and AHR are alarm differentials which relate to SP and SP + HYS	
ALA	-50 ... 120°	Low temperature alarm threshold	
AHA	-50 ... 120°	High temperature alarm threshold	
ALR	-12 ... 0°	Low temperature alarm differential (With ALR = 0 the low temperature alarm is excluded)	-5
AHR	0 ... 12°	High temperature alarm differential (With AHR = 0 the low temperature alarm is excluded)	5
ATI		<b>Alarm probe:</b>	T1
	T1	Air temperature probe used for alarm detection	
	T2	Evaporator temperature probe used for alarm detection	
ATD	0... 120min	Delay before alarm temperature warning	90
ADO	0... 30min	Delay before door open alarm warning	8

AHM		<b>Operation in case of high condenser alarm (T2 = CND)</b>	NON
	NON	High condenser temperature alarm inhibited	
	ALR	Condenser warning – ‘HC’ displayed, alarm sounds	
	STP	As ‘ALR’ with compressor stopped and defrosts suspended	
AHT	-50 ... 120°	Condenser alarm temperature (T2 = CND)	65
ACC	0...52 Weeks	Condenser cleaning period. (With ACC = 0 condenser cleaning is disabled)	0
IISM		<b>Switchover method to second parameter set:</b>	HDD
	NON	Second parameter set is excluded	
	MAN	Second parameter set is activated/ deactivated by button 	
	HDD	Second parameter activated by ‘heavy’ usage	
	D12	Second parameter set activated by D12 input (D12 = IISM)	
IISL	-50 . IISH	Minimum limit for IISP setting	1
IISH	IISL .. 120°	Maximum limit for IISP setting	1
IISP	IISP...IISH	Temperature set point to be achieved in ‘Mode 2’	1
IIHY	1 ... 10°	Off/on thermostat differential in ‘Mode 2’	3
IIFC		<b>Evaporator fan mode during ‘Mode 2’ thermostatic control:</b>	NON
	NON	Fans(s) run continuously	
	TMP	Temperature based control. When compressor is on, fans are on. When compressor is off, fans run as long as temperature difference $T_e - T_a > FDT$ . Fans on again with FDH	
	TIM	Time based control. When compressor is on, fans are on. When compressor is off, fans in accordance to parameters FT1, FT2 and FT3.	
HDS	1 ... 5	Controller sensitivity for switch over between ‘Modes’ and 2. (1 = minimum, 5 = maximum)	3
IIDF	0 ... 99hours	Time interval between defrosts in ‘Mode 2’.	6
SB		<b>Standby button operation:</b>	YES
	YES	Standby button enabled	
	No	Standby button disabled	
DS		<b>Door switch operation (switch made when door closed):</b>	YES
	YES	Door switch enabled	
	NO	Door switch disabled	
DI2		<b>Configuration digital input operation:</b>	NON
	NON	Digital input 2 not activated	
	HPS	High pressure alarm when contact opens	
	IISM	‘Mode 2’ parameters active when contact closes	
	RDS	Defrost initiated when contact closes	
	DS2	Second door switch function (operated ‘in series’ with DS)	
LSM		<b>Light control mode:</b>	NON
	NON	Digital input 2 not activated	
	MAN	Light output operation is activated/deactivated by button  (With OA1 = LGT)	
	DOR	Light output is switched on when door is opened (With OA1 = LGT and DS = YES)	
	NDR	Light output is switched off when door is opened. (With OA1 = LGT and DS = YES)	

OA1		<b>Auxiliary relay operation:</b>	NON
	NON	Output disabled (always off)	
	0-1	Contacts open/close with standby/on mode	
	LGT	Output enabled for light control	
	AL0	Contacts open when an alarm condition occurs	
	AL1	Contacts close when an alarm condition occurs (Relay contacts open when in standby mode)	
INP		<b>Temperature sensor(s) type:</b>	SN4
	SN4	10k NTC type thermistor (red writing)	
	ST1	1k PTC type thermistor (Black Writing)	
OS1	-12.5...12.5°C	Air temperature probe (T1) offset.	0
T2		<b>T2 Probe function:</b>	NON
	NON	T2 Probe disabled	
	EPO	Evaporator temperature monitoring	
	CND	Condenser temperature monitoring	
OS2	-12.5...12.5°C	T2 probe temperature offset	0
TLD	1 ... 30min	Delay for min (TLO) and max. (THI) temperature logging	10
SIM	0 ... 100	Display Slowdown	5
ADR	1... 255	FD2-10 address for PC communication	1

## Individual Unit Controller Parameter Values

Parameters ALA and AHA will not be visible when ATM is set at REL. Parameters ALR and AHR will not be visible if ATM is changed to ABS.

Light Grey highlights differences from default parameter.

FOSTER FD2-10					Default	High-Temp Single Door & EPRO20BSR	High-Temp Double Door & EPRO40BSR	High-Temp Counter	Low-Temp Single Door Integral	Low-Temp Double Door Integral	Low-Temp Single Door Remote	Low-Temp Double Door Remote	Low-Temp Counter Integral	Low-Temp Counter Remote	Meat-Temp Single Door Integral	Meat-Temp Double Door Integral	Meat-Temp Single Door Remote	Meat-Temp Double Door Remote	Meat-Temp Counter Integral	Meat-Temp Counter Remote	Wine-Temp Single Door	Wine-Temp Double Door	EPRO20BSF & 40BSF Integral	PRO G1350F-A	PRO G600F-A	Greggs 20BSR	Greggs 40BSR
Reg	Par	Min	Mid	Max	Description	A	B	C	D	E	F	G	H	I	J	K	L	M	N	O	P	Q	R	AE	AF	W	X
253	SCL	1°C	°F	2°C	Readout scale.	2°C	2°C	2°C	2°C	2°C	2°C	2°C	2°C	2°C	2°C	2°C	2°C	2°C	2°C	2°C	2°C	2°C	2°C	2°C	2°C	2°C	2°C
200	SPL	-50°	...	SPH	Minimum limit for SP setting.	1	1	1	-21	-21	-21	-21	-21	-21	-2	-2	-2	-2	-2	-2	8	8	-21	-1	-1	0	0
202	SPH	SPL	...	120°	Maximum limit for SP setting.	3	3	3	-19	-19	-19	-19	-19	-19	0	0	0	0	0	0	12	12	-16	1	1	10	10
204	SP	SPL	...	SPH	Temperature set point to be achieved.	1	1	1	-21	-21	-21	-21	-21	-21	-2	-2	-2	-2	-2	-2	10	10	-26	-1	-1	1	1
268.1	C-H	REF	...	HEA	Temperature control mode.	REF	REF	REF	REF	REF	REF	REF	REF	REF	REF	REF	REF	REF	REF	REF	REF	REF	REF	REF	REF	REF	
214	HYS	1°	...	10°	Off / On thermostat differential.	4	4	4	4	4	4	4	4	4	3	3	3	3	3	3	3	3	3	3	3	3	
216	CRT	0 min	...	30 min	Compressor rest time.	2	2	2	2	2	2	2	2	2	2	2	2	2	2	2	2	2	2	2	2	2	
217	CT1	0 min	...	30 min	Thermostat run time with faulty T1 probe.	6	6	6	6	6	6	6	6	6	6	6	6	6	6	6	6	6	6	6	6	6	
218	CT2	0 min	...	30 min	Thermostat off time with faulty T1 probe.	4	4	4	4	4	4	4	4	4	4	4	4	4	4	4	4	4	4	4	4	4	
219	CSD	0 min	...	30 min	Compressor stop delay after door has been opened. (Only if DS = YES).	1	1	1	1	1	1	1	1	1	1	1	1	1	1	1	1	1	1	1	1	1	
220	DFM	NON	FRO	TIM	Defrost start mode.	TIM	TIM	TIM	TIM	TIM	TIM	TIM	TIM	TIM	TIM	TIM	TIM	TIM	TIM	TIM	TIM	TIM	TIM	TIM	TIM	TIM	
221	DFT	0 hrs	...	99 hrs	Time interval between defrosts.	6	6	6	6	6	6	6	6	6	6	6	6	6	6	6	6	6	4	0	0	4	4
268.4	DFB	NO	...	YES	Defrost timer clock.	YES	YES	YES	YES	YES	YES	YES	YES	YES	YES	YES	YES	YES	YES	YES	YES	YES	YES	YES	YES	YES	

Reg	Par	Min	Mid	Max	Description		A	B	C	D	E	F	G	H	I	J	K	L	M	N	O	P	Q	R	AE	AF	W	X		
206	DLI	-50°	...	120°	Defrost end temperature (Only if T2 = EPO).	20	20	20	20	20	20	20	20	20	20	20	20	20	20	20	20	20	20	20	20	20	20	20	20	
223	DTO	1 min	...	120 min	Maximum defrost duration.	20	20	20	20	20	20	20	20	20	20	20	20	20	20	20	20	20	20	20	20	20	20	20	20	
224	DTY	OFF	ELE	GAS	Defrost type.	OFF	OFF	OFF	OFF	GAS	GAS	ELE	ELE	GAS	ELE	GAS	GAS	ELE	ELE	GAS	ELE	OFF	OFF	GAS	OFF	OFF	OFF	OFF	OFF	
225	DPD	0 sec	...	240 sec	Evaporator pump down. Timed pause at start of defrost.	0	0	0	0	0	0	0	0	0	0	0	0	0	0	0	0	0	0	0	0	0	0	0	0	
226	DRN	0 min	...	30 min	Drain down period.	2	2	2	2	2	2	2	2	2	2	2	2	2	2	2	2	2	2	2	2	2	2	2	2	
227	DDM	RT	SP DEF	LT	Defrost display mode.	DEF	DEF	DEF	DEF	DEF	DEF	DEF	DEF	DEF	DEF	DEF	DEF	DEF	DEF	DEF	DEF	DEF	DEF	DEF	DEF	DEF	DEF	DEF	DEF	
228	DDY	0 min	...	60 min	Defrost display delay period.	10	10	10	10	10	10	10	10	10	10	10	10	10	10	10	10	10	10	10	10	10	10	10	10	10
267.5	FID	NO	...	YES	Fans in defrost.	YES	YES	YES	YES	NO	NO	NO	NO	NO	NO	NO	NO	NO	NO	NO	NO	YES	YES	NO	YES	YES	YES	YES	YES	
207	FDD	-50°	...	120°	Evaporator fan restart temperature following defrost. (Only if T2 = EPO).	5	5	5	5	0	0	0	0	0	0	0	0	0	0	0	0	5	5	0	5	5	5	5	5	
229	FTO	0 min	...	120 min	Maximum evaporator fan stop period following defrost.	3	3	3	3	3	3	3	3	3	3	3	3	3	3	3	3	3	3	3	3	3	3	3	3	
237	FDS	0 sec	...	120 sec	Minimum evaporator fan stop (following door opening etc.).	20	20	20	20	20	20	20	20	20	20	20	20	20	20	20	20	20	20	20	20	20	20	20	20	
230	FCM	NON	TIM	TMP	Evaporator fan mode during thermostatic control.	TIM	TIM	TIM	TIM	TIM	TIM	TIM	TIM	TIM	TIM	TIM	TIM	TIM	TIM	TIM	TIM	TIM	TIM	TIM	TIM	TIM	TIM	TIM	TIM	
232	FDT	-120°	...	0°	Te-Ta difference for fans to turn off after compressor stopped. (Only if T2 = EPO and FCM = TMP).	-1	-1	-1	-1	-1	-1	-1	-1	-1	-1	-1	-1	-1	-1	-1	-1	-1	-1	-1	-1	-1	-1	-1	-1	
233	FDH	1°	...	120°	Temperature differential for evaporator fan restart. (Only if T2 = EPO and FCM = TMP).	3	3	3	3	3	3	3	3	3	3	3	3	3	3	3	3	3	3	3	3	3	3	3	3	
234	FT1	0 sec	...	180 sec	Fan stop delay after compressor stop.	15	15	15	15	15	15	15	15	15	15	15	15	15	15	15	15	15	15	15	15	15	15	15	15	
235	FT2	0 min	...	30 min	Timed fan stop following FT1. (With FT2 = 0 the fans remain on all the time).	3	3	3	0	3	3	3	3	0	0	3	3	3	3	0	0	3	3	3	3	3	3	3	3	

Reg	Par	Min	Mid	Max	Description		A	B	C	D	E	F	G	H	I	J	K	L	M	N	O	P	Q	R	AE	AF	W	X
236	FT3	0 min	...	30 min	Timed fan run following FT2. (With FT3 = 0 & FT2 > 0 the fans remain off all the time).	2	2	2	2	2	2	2	2	2	2	2	2	2	2	2	2	2	2	2	0	0	2	2
238	ATM	NON	REL	ABS	Alarm threshold configuration.	REL	REL	REL	REL	REL	REL	REL	REL	REL	REL	REL	REL	REL	REL	REL	REL	REL	REL	REL	REL	REL	REL	REL
208	ALA	-50°	...	120°	Low temperature alarm threshold.	-2	-2	-2	-2	-2	-2	-2	-2	-2	-2	-2	-2	-2	-2	-2	-2	-2	-2	-2	-2	-2	-2	-2
209	AHA	-50°	...	120°	High temperature alarm threshold.	8	8	8	8	8	8	8	8	8	8	8	8	8	8	8	8	8	8	8	8	8	8	8
239	ALR	-12°	...	0°	Low temperature alarm differential. (With ALR = 0 the low temperature alarm is excluded).	-5	-5	-5	-5	-5	-5	-5	-5	-5	-5	-5	-5	-5	-5	-5	-5	-5	-5	-5	-5	-5	-5	-5
240	AHR	0°	...	12°	High temperature alarm differential. (With AHR = 0 the low temperature alarm is excluded).	5	5	5	5	5	5	5	5	5	5	5	5	5	5	5	5	5	5	5	5	5	5	5
241	ATI	T1	...	T2	Alarm probe.	T1	T1	T1	T1	T1	T1	T1	T1	T1	T1	T1	T1	T1	T1	T1	T1	T1	T1	T1	T1	T1	T1	T1
242	ATD	0 min	...	120 min	Delay before alarm temperature warning.	90	90	90	90	90	90	90	90	90	90	90	90	90	90	90	90	90	90	90	90	90	90	90
243	ADO	0 min	...	30 min	Delay before door open alarm warning.	8	8	8	8	8	8	8	8	8	8	8	8	8	8	8	8	8	8	8	8	8	8	8
244	AHM	NON	STP	ALR	Operation in case of high condenser alarm (T2 = CND).	NON	NON	NON	NON	NON	NON	NON	NON	NON	NON	NON	NON	NON	NON	NON	NON	NON	NON	NON	NON	NON	NON	NON
210	AHT	-50°	...	120°	Condenser alarm temperature (T2 = CND).	65	65	65	65	65	65	65	65	65	65	65	65	65	65	65	65	65	65	65	65	65	65	65
245	ACC	0 wks	...	52 wks	Condenser cleaning period. (With ACC = 0 condenser cleaning is disabled).	0	0	0	0	0	0	0	0	0	0	0	0	0	0	0	0	0	0	0	0	0	0	0
247	IISM	NON	HDD DI2	MAN	Switchover method to second parameter set.	HDD	HDD	HDD	HDD	HDD	HDD	HDD	HDD	HDD	HDD	HDD	HDD	HDD	HDD	HDD	HDD	NON	NON	NON	NON	NON	HDD	HDD
201	IISL	-50°	...	IISH	Minimum limit for IISP setting.	1	1	1	1	-21	-21	-21	-21	-21	-21	-2	-2	-2	-2	-2	-2	1	1	-21	1	1	0	0
203	IISH	IISL	...	120°	Maximum limit for IISP setting.	1	1	1	1	-21	-21	-21	-21	-21	-21	0	0	0	0	0	0	1	1	-16	1	1	10	10

Reg	Par	Min	Mid	Max	Description		A	B	C	D	E	F	G	H	I	J	K	L	M	N	O	P	Q	R	AE	AF	W	X
205	IISP	IISL	...	IISH	Temperature set point to be achieved in 'Mode 2'.	1	1	1	1	-21	-21	-21	-21	-21	-21	-2	-2	-2	-2	-2	-2	1	1	-16	1	1	1	1
215	IIHY	1°	...	10°	Off / On thermostat differential in 'Mode 2'.	4	4	4	4	4	4	4	4	4	4	3	3	3	3	3	3	4	4	3	4	4	3	3
231	IIFC	NON	TIM	TMP	Evaporator fan mode during 'Mode 2' thermostatic control.	NON	NON	NON	NON	NON	NON	NON	NON	NON	NON	NON	NON	NON	NON	NON	NON	NON	NON	NON	NON	NON	NON	NON
246	HDS	1	...	5	Controller sensitivity for switch over between 'Modes' 1 and 2. (1 = minimum, 5 = maximum).	3	3	3	3	3	3	3	3	3	3	3	3	3	3	3	3	3	3	3	3	3	3	3
222	IIDF	0 hrs	...	99 hrs	Time interval between defrosts in 'Mode 2'.	6	6	6	6	6	6	6	6	6	6	6	6	6	6	6	6	6	6	6	6	6	6	6
268.7	SB	NO	...	YES	Standby button operation.	YES	YES	YES	YES	YES	YES	YES	YES	YES	YES	YES	YES	YES	YES	YES	YES	YES	YES	YES	YES	YES	YES	YES
268.0	DS	NO	...	YES	Door switch operation (switch made when door closed).	YES	YES	YES	NO	YES	YES	YES	YES	NO	NO	YES	YES	YES	YES	NO	NO	YES	YES	YES	YES	YES	YES	YES
251	DI2	NON	IISM RDS DS2	HPS	Configurable digital input operation.	NON	NON	DS2	NON	NON	DS2	NON	DS2	NON	NON	NON	DS2	NON	DS2	NON	NON	NON	DS2	HPS	DS2	NON	NON	DS2
248	LSM	NON	DOR NDR	MAN	Light control mode.	NON	NON	NON	NON	NON	NON	NON	NON	NON	NON	NON	NON	NON	NON	NON	NON	NON	NON	NON	NON	NON	NON	NON
249	OA1	NON	LGT AL0 AL1	0-1	Auxiliary relay operation.	0-1	0-1	0-1	0-1	0-1	0-1	0-1	0-1	0-1	0-1	0-1	0-1	0-1	0-1	0-1	0-1	0-1	0-1	0-1	0-1	0-1	0-1	0-1
268.2	INP	ST1	...	SN4	Temperature sensor(s) type.	SN4	SN4	SN4	SN4	SN4	SN4	SN4	SN4	SN4	SN4	SN4	SN4	SN4	SN4	SN4	SN4	SN4	SN4	SN4	SN4	SN4	SN4	SN4
256	OS1	-12.5°C	...	12.5°C	Air temperature probe (T1) offset.	0	0	0	0	0	0	0	0	0	0	0	0	0	0	0	0	0	0	0	0	0	0	0
250	T2	NON	EVP	CND	T2 probe function.	NON	NON	NON	NON	EVP	EVP	EVP	EVP	EVP	EVP	EVP	EVP	EVP	EVP	EVP	EVP	NON	NON	EVP	NON	NON	NON	NON
251	OS2	12.5° C	...	12.5° C	T2 probe temperature offset.	0	0	0	0	0	0	0	0	0	0	0	0	0	0	0	0	0	0	0	0	0	0	0
252	TLD	1 min	...	30 min	Delay for min. (TLO) and max. (THI) temperature logging.	10	10	10	10	10	10	10	10	10	10	10	10	10	10	10	10	10	10	10	10	10	10	10
254	SIM	0	...	100	Display slowdown.	5	5	5	5	5	5	5	5	5	5	5	5	5	5	5	5	5	5	5	5	5	5	5
255	ADR	1	...	255	FD2-10 address for PC communication	1	1	1	1	1	1	1	1	1	1	1	1	1	1	1	1	1	1	1	1	1	1	1

## Technical Data EPro Cabinets & Counters

Cabinet Models	Gas	Gas Charge	Compressor	Capillary	Defrost Type	Voltage	Power Consumption		Fuse Rating
							Watts	Amps	
EPRO G 500H	R134A	380 grms	FR7.5GX	2.8m x 0.042	Timed Off Cycle	230/50/1	295	2.1	13 Amp
EPRO G 500L	R404A	360 grms	SC15CL	3.0m x 0.047	Hot Gas	230/50/1	641	3.1	13 Amp
EPRO G 600H	R134A	380 grms	FR7.5GX	2.8m x 0.042	Timed Off Cycle	230/50/1	349	2.5	13 Amp
EPRO G 600M	R134A	380 grms	FR7.5GX	2.8m x 0.042	Hot Gas	230/50/1	389	2.7	13 Amp
EPRO G 600L	R404A	360 grms	SC15CL	3.0m x 0.047	Hot Gas	230/50/1	709	3.4	13 Amp
EPRO G 600LU	R404A	325 grms	SC15CLX	3.0m x 0.042	Electric	230/50/1	610	4.1	13 Amp
EPRO G 600HU	R134A	350 grms	FR7.5GX	3.0m x 0.042	Timed Off Cycle	230/50/1	248	1.9	13 Amp
EPRO G 600MU	R134A	350 grms	FR7.5GX	3.0m x 0.042	Electric	230/50/1	282	2.1	13 Amp
EPRO G 1100H	R134A	450 grms	SC15GX	3.0m x 0.054	Timed Off Cycle	230/50/1	567	3.8	13 Amp
EPRO G 1100L	R404A	660 grms	CAJ2446Z-SE	3.0m x 0.054	Hot Gas	230/50/1	920	4.5	13 Amp
EPRO G 1350H	R134A	450 grms	SC15GX	3.0m x 0.054	Timed Off Cycle	230/50/1	655	4.7	13 Amp
EPRO G 1350M	R134A	450 grms	SC15GX	3.0m x 0.054	Hot Gas	230/50/1	738	5.0	13 Amp
EPRO G 1350L	R404A	660 grms	CAJ2446Z-SE	3.0m x 0.054	Hot Gas	230/50/1	934	4.6	13 Amp
EPRO G 300/300 HL	R134A	320 grms	FR7.5GX	3.0m x 0.042	Timed Off Cycle	230/50/1	936	5.1	13 Amp
	R404A	300 grms	SC15CL	3.0m x 0.042	Electric	230/50/1			13 Amp
EPRO B 600H	R134A	380 grms	FR7.5GX	2.8m x 0.042	Timed Off Cycle	230/50/1	349	2.5	13 Amp
EPRO B 600L	R404A	360 grms	SC15CL	3.0m x 0.047	Hot Gas & Electric	230/50/1	709	3.4	13 Amp
PRO G 600F	R134A	270 grms	FR7.5GX	3.0m x 0.054	Timed Off Cycle	230/50/1	349	2.4	13 Amp
EPRO 20 BSR	R134A	380 grms	FR7.5GX	2.8m x 0.042	Timed Off Cycle	230/50/1	349	2.5	13 Amp
EPRO 20 BSF	R404A	360 grms	SC15CL	3.0m x 0.047	Hot Gas	230/50/1	709	3.4	13 Amp
EPRO 40 BSR	R134A	450 grms	SC15GX	3.0m x 0.054	Timed Off Cycle	230/50/1	655	4.7	13 Amp
EPRO 40 BSF	R404A	660 grms	CAJ2446Z-SE	3.0m x 0.054	Hot Gas	230/50/1	934	4.6	13 Amp

Counter Models	Gas	Gas Charge	Compressor	Capillary	Defrost Type	Voltage	Power Consumption		Fuse Rating
							Watts	Amps	
EPRO 1/2H	R134A	315 grms	FR7.5GX	3.0m X 0.042	Timed Off Cycle	230/50/1	290	2	13 Amp
EPRO 1/2M	R134A	315 grms	FR7.5GX	3.0m X 0.042	Hot Gas	230/50/1	330	2.1	13 Amp
EPRO 1/2L	R404A	335 grms	SC15CL	3.0m X 0.042	Hot Gas	230/50/1	670	3.2	13 Amp
EPRO 1/3H	R134A	315 grms	FR7.5GX	3.0m X 0.042	Timed Off Cycle	230/50/1	340	2.4	13 Amp
EPRO 1/3M	R134A	315 grms	FR7.5GX	3.0m X 0.042	Hot Gas	230/50/1	400	2.6	13 Amp
EPRO 1/3L	R404A	360 grms	SC15CL	3.0M X 0.042	Hot Gas	230/50/1	690	3.3	13 Amp
EPRO 1/4H	R134A	370 grms	SC12GX	3.0M X 0.054	Timed Off Cycle	230/50/1	520	3.4	13 Amp
EPRO 1/4M	R134A	370 grms	SC12GX	3.0m X 0.054	Hot Gas	230/50/1	600	3.7	13 Amp
EPRO 1/4L	R404A	375 grms	SC21CLX	3.0m X 0.054	Hot Gas	230/50/1	810	3.8	13 Amp
EPRO 2/2H	R134A	365 grms	FR7.5GX	3.0m X 0.042	Timed Off Cycle	230/50/1	380	2.6	13 Amp
EPRO 2/2L	R404A	360 grms	SC15CL	3.0m X 0.042	Hot Gas	230/50/1	710	3.4	13 Amp
EPRO 2/3H	R134A	380 grms	SC12GX	3.0m X 0.054	Timed Off Cycle	230/50/1	550	3.6	13 Amp
EPRO 2/3L	R404A	380 grms	SC21CLX	3.0m X 0.054	Hot Gas	230/50/1	840	4	13 Amp



### Technical Data EPro Cabinets & Counters using R290 Refrigerant

Cabinet Models	Gas	Gas Charge	Compressor	Capillary	Defrost Type	Voltage	Power Consumption		Fuse Rating
							Watts	Amps	
EPRO G 500H	R290	150 grms	TL5CNX	2.8m x 0.042	Timed Off Cycle	230/50/1	295	2.1	13 Amp
EPRO G 500L	R290	150 grms	SC15CNX	3.0m x 0.042	Hot Gas	230/50/1	641	3.1	13 Amp
EPRO G 600H	R290	150 grms	TL5CNX	2.8m x 0.042	Timed Off Cycle	230/50/1	349	2.5	13 Amp
EPRO G 600HU	R290	150 grms	TL5CNX	3.0m x 0.042	Timed Off Cycle	230/50/1	248	1.9	13 Amp
EPRO G 600M	R290	150 grms	TL5CNX	2.8m x 0.042	Hot Gas	230/50/1	389	2.7	13 Amp
EPRO G 600L	R290	150 grms	SC15CNX	3.0m x 0.042	Hot Gas	230/50/1	709	3.4	13 Amp
EPRO G 1100H	R290	150 grms	SC12CNX	3.0m x 0.054	Timed Off Cycle	230/50/1	567	3.8	13 Amp
EPRO G 1100L	R290	220 grms	MX23FB	3.0m x 0.054	Hot Gas	230/50/1	920	4.5	13 Amp
EPRO G 1350H	R290	150 grms	SC12CNX	3.0m x 0.054	Timed Off Cycle	230/50/1	655	4.7	13 Amp
EPRO G 1350M	R290	150 grms	SC12CNX	3.0m x 0.054	Hot Gas	230/50/1	738	5.0	13 Amp
EPRO G 1350L	R290	220 grms	MX23FB	3.0m x 0.054	Hot Gas	230/50/1	934	4.6	13 Amp
EPRO B 600H	R290	150 grms	TL5CNX	2.8m x 0.042	Timed Off Cycle	230/50/1	349	2.5	13 Amp
EPRO B 600L	R290	150 grms	SC15CNX	3.0m x 0.042	Hot Gas & Electric	230/50/1	709	3.4	13 Amp
EPRO 20 BSR	R290	150 grms	TL5CNX	2.8m x 0.042	Timed Off Cycle	230/50/1	349	2.5	13 Amp
EPRO 20 BSF	R290	150 grms	SC15CNX	3.0m x 0.042	Hot Gas	230/50/1	709	3.4	13 Amp
EPRO 40 BSR	R290	150 grms	SC12CNX	3.0m x 0.054	Timed Off Cycle	230/50/1	655	4.7	13 Amp
EPRO 40 BSF	R290	220 grms	MX23FB	3.0m x 0.054	Hot Gas	230/50/1	934	4.6	13 Amp

Counter Models	Gas	Gas Charge	Compressor	Capillary	Defrost Type	Voltage	Power Consumption		Fuse Rating
							Watts	Amps	
EPRO 1/2H	R290	150 grms	TL5CNX	3.0m X 0.042	Timed Off Cycle	230/50/1	290	2	13 Amp
EPRO 1/2M	R290	150 grms	TL5CNX	3.0m X 0.042	Hot Gas	230/50/1	330	2.1	13 Amp
EPRO 1/2L	R290	150 grms	SC15CNX	3.0m X 0.042	Hot Gas	230/50/1	670	3.2	13 Amp
EPRO 1/3H	R290	150 grms	TL5CNX	3.0m X 0.042	Timed Off Cycle	230/50/1	340	2.4	13 Amp
EPRO 1/3M	R290	150 grms	TL5CNX	3.0m X 0.042	Hot Gas	230/50/1	400	2.6	13 Amp
EPRO 1/3L	R290	150 grms	SC15CNX	3.0m X 0.042	Hot Gas	230/50/1	690	3.3	13 Amp
EPRO 1/4H	R290	150 grms	SC12CNX	3.0m X 0.054	Timed Off Cycle	230/50/1	520	3.4	13 Amp
EPRO 1/4M	R290	150 grms	SC12CNX	3.0m X 0.054	Hot Gas	230/50/1	600	3.7	13 Amp
EPRO 2/2H	R290	150 grms	TL5CNX	3.0m X 0.042	Timed Off Cycle	230/50/1	380	2.6	13 Amp
EPRO 2/2L	R290	150 grms	SC15CNX	3.0m X 0.042	Hot Gas	230/50/1	710	3.4	13 Amp
EPRO 2/3H	R290	150 grms	SC12CNX	3.0m X 0.054	Timed Off Cycle	230/50/1	550	3.6	13 Amp

**Note:** The Power Consumption values referred to as tested are to the ECA test standard. Actual power consumption will be greatly affected by ambient temperature, loading, usage and cabinet maintenance.

# High Temperature Models Wiring Diagram

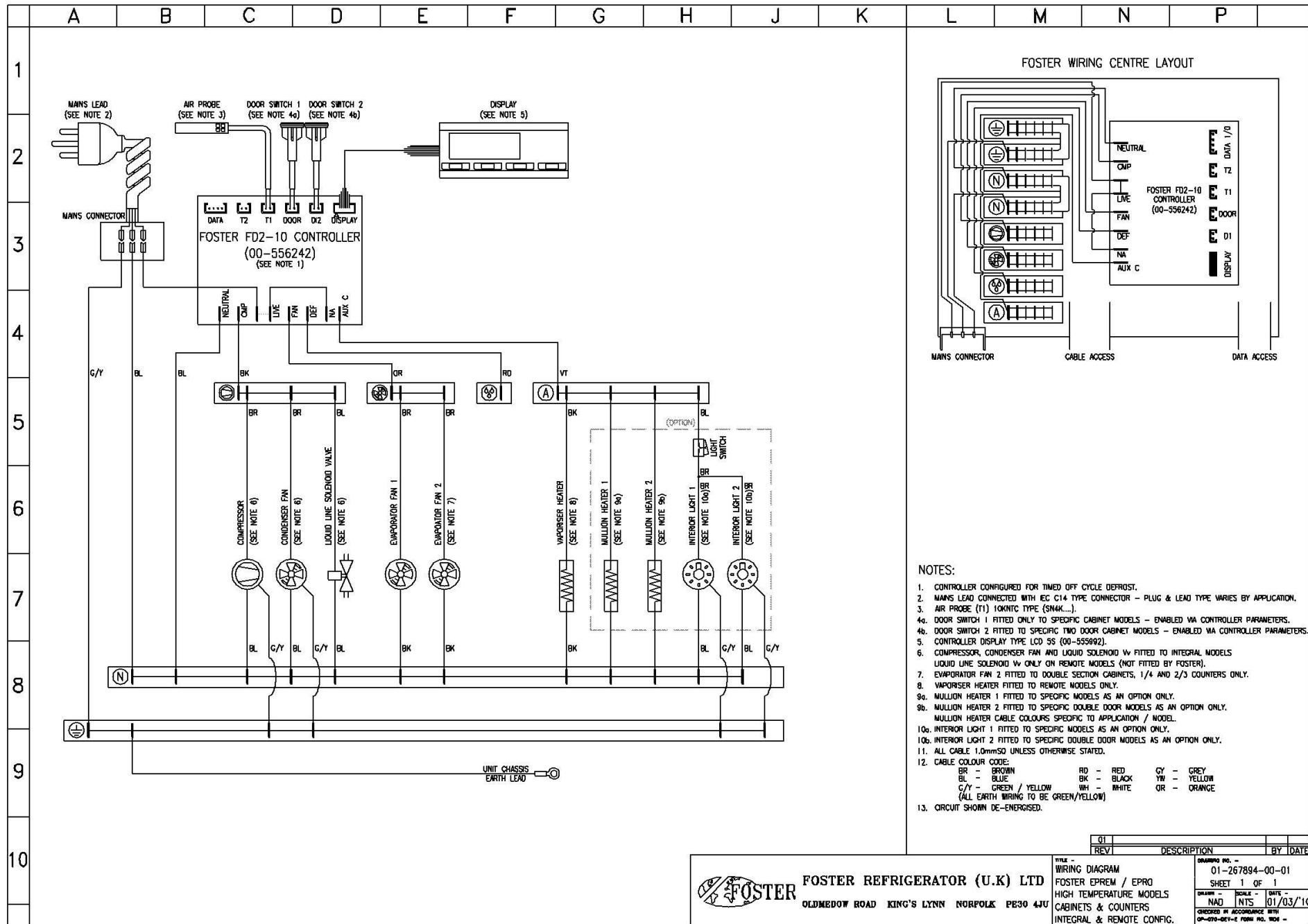

Q1	DESCRIPTION	BY	DATE
REV			



**FOSTER REFRIGERATOR (U.K) LTD**  
 OLDMEADOW ROAD KING'S LYNN NORFOLK PE30 4JU

TITLE - WIRING DIAGRAM  
 FOSTER EPREM / EPRO  
 HIGH TEMPERATURE MODELS  
 CABINETS & COUNTERS  
 INTEGRAL & REMOTE CONFIG.

DRAWING NO. - 01-267894-00-01  
 SHEET 1 OF 1  
 DRAWN - MAD  
 CHECKED BY ACCORDANCE WITH  
 DATE - 01/03/10  
 QP-070-02V-C FORM NO. 100 -

# Low/Meat Temperature Models Wiring Diagram

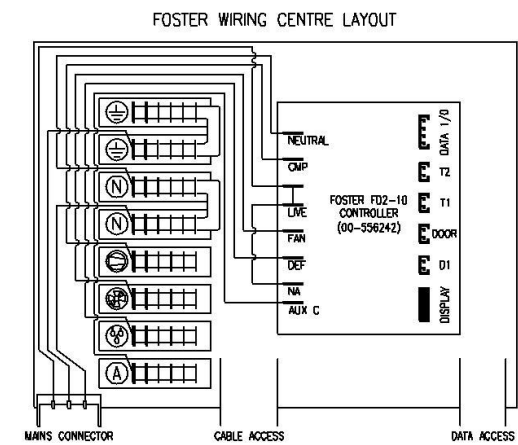
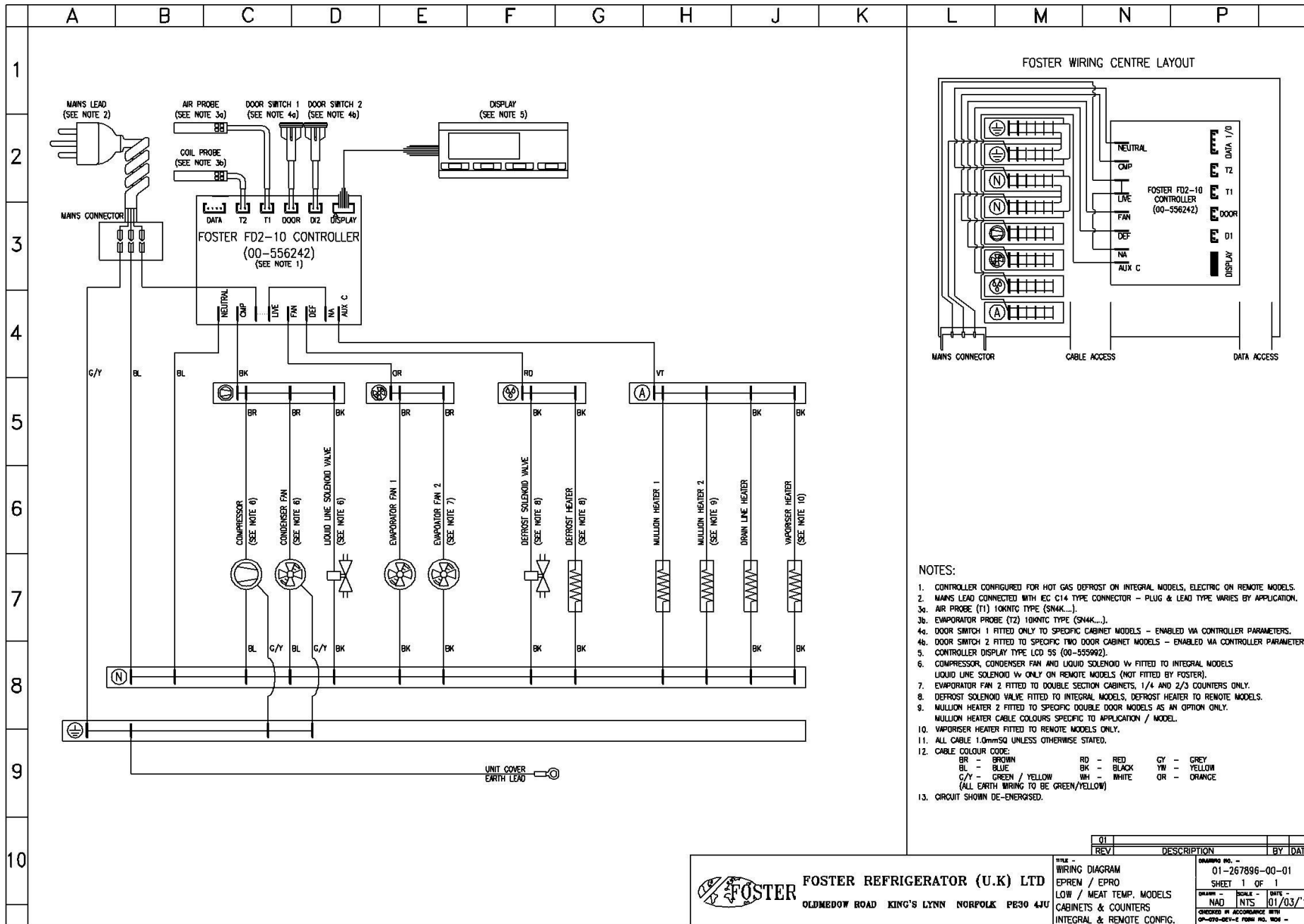

**NOTES:**

- CONTROLLER CONFIGURED FOR HOT GAS DEFROST ON INTEGRAL MODELS, ELECTRIC ON REMOTE MODELS.
- MAINS LEAD CONNECTED WITH IEC C14 TYPE CONNECTOR - PLUG & LEAD TYPE VARIES BY APPLICATION.
- AIR PROBE (T1) 10K $\Omega$  TYPE (SN4K...).
- EVAPORATOR PROBE (T2) 10K $\Omega$  TYPE (SN4K...).
- DOOR SWITCH 1 FITTED ONLY TO SPECIFIC CABINET MODELS - ENABLED VIA CONTROLLER PARAMETERS.
- DOOR SWITCH 2 FITTED TO SPECIFIC TWO DOOR CABINET MODELS - ENABLED VIA CONTROLLER PARAMETERS.
- CONTROLLER DISPLAY TYPE LCD 5S (00-555992).
- COMPRESSOR, CONDENSER FAN AND LIQUID SOLENOID VV FITTED TO INTEGRAL MODELS LIQUID LINE SOLENOID VV ONLY ON REMOTE MODELS (NOT FITTED BY FOSTER).
- EVAPORATOR FAN 2 FITTED TO DOUBLE SECTION CABINETS, 1/4 AND 2/3 COUNTERS ONLY.
- DEFROST SOLENOID VALVE FITTED TO INTEGRAL MODELS, DEFROST HEATER TO REMOTE MODELS.
- MULLION HEATER 2 FITTED TO SPECIFIC DOUBLE DOOR MODELS AS AN OPTION ONLY. MULLION HEATER CABLE COLOURS SPECIFIC TO APPLICATION / MODEL.
- VAPOURISER HEATER FITTED TO REMOTE MODELS ONLY.
- ALL CABLE 1.0mm<sup>2</sup> UNLESS OTHERWISE STATED.
- CABLE COLOUR CODE:  
 BR - BROWN      RD - RED      GY - GREY  
 BL - BLUE      BK - BLACK      YW - YELLOW  
 C/Y - GREEN / YELLOW      WH - WHITE      OR - ORANGE  
 (ALL EARTH WIRING TO BE GREEN/YELLOW)
- CIRCUIT SHOWN DE-ENERGISED.

REV	DESCRIPTION	BY	DATE
01			

	<b>FOSTER REFRIGERATOR (U.K) LTD</b> OLDMEDOW ROAD KING'S LYNN NORFOLK PE30 4JU	TITLE - WIRING DIAGRAM EPREN / EPRO LOW / MEAT TEMP. MODELS CABINETS & COUNTERS INTEGRAL & REMOTE CONFIG.	DRAWING NO. - 01-267896-00-01 SHEET 1 OF 1 DRAWN BY - NAD CHECKED BY - NTS DATE - 01/03/10 <small>CONFORMS TO ACCORDANCE WITH                  EN-60959-2-2 FORM NO. 100 -</small>
--	--	--	---



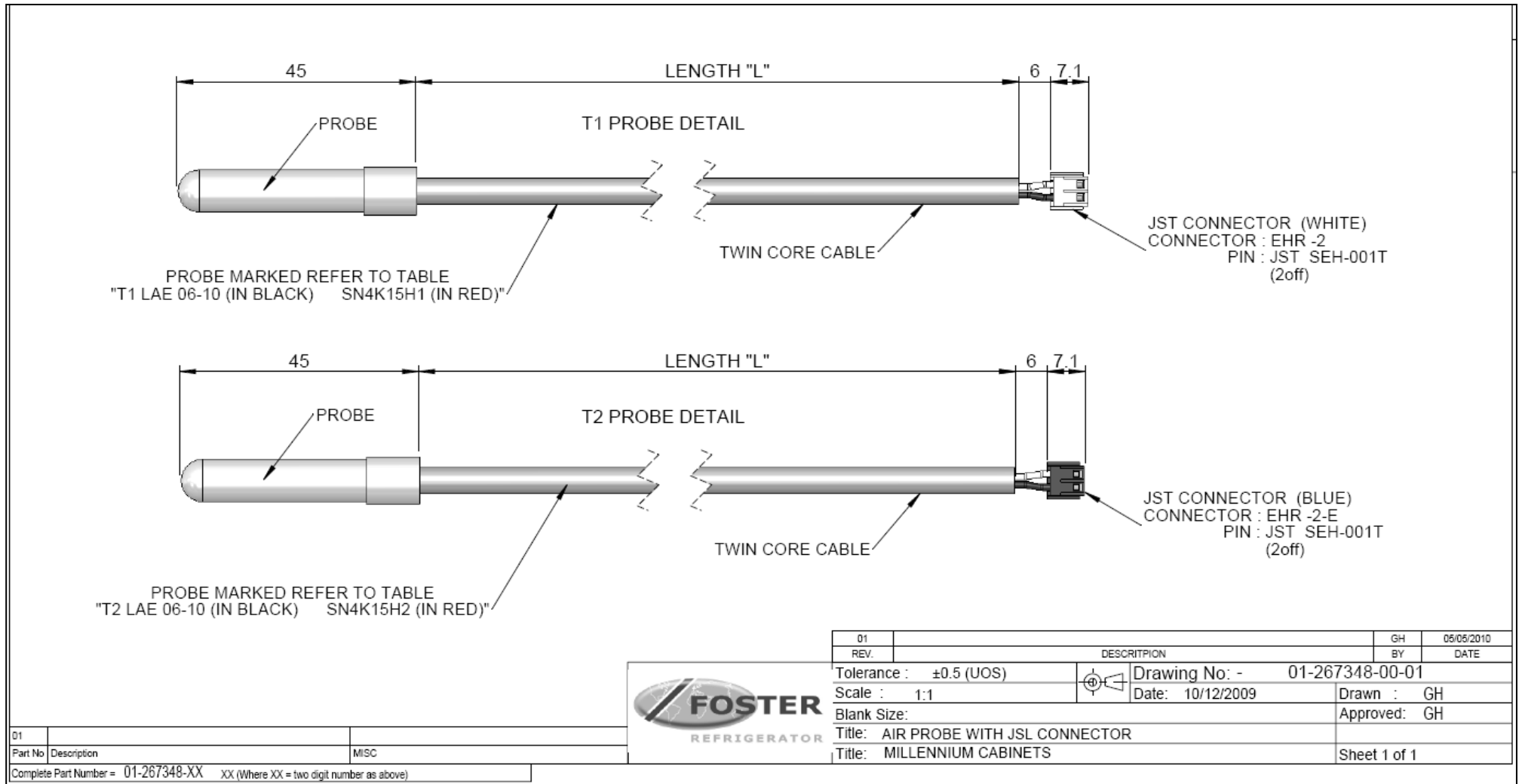





# Air and Evaporator Probe Details / Diagram















Probe Air 2.5M SN4B15H1 (00-556284)

Probe Evap 2.5M SN4KB15H2 (00-556287)

## Troubleshooting

Problem	Possible Cause	Solution
<b>Compressor will not start</b>	No voltage in socket	Use voltmeter to check
	Electrical conductor or wires may be cut	Use ohmmeter to check for continuity
	Defective electrical component: thermostat, relay, thermal protector etc	Replace defective component
	Compressor motor has a winding open or shorted	Measure ohmic resistance of main and auxiliary winding using ohmmeter. Compare with correct values
	Compressor stuck	Change compressor
	Temperature control contacts are open	Repair or replace the contacts
	Incorrect wiring	Check wiring diagram and correct
	Fuse blown or circuit breaker tripped.	Replace fuse or reset circuit breaker
	Power cord unplugged	Plug in power cord.
	Controller set too high	Set controller to lower temperature.
	Cabinet in defrost cycle	Wait for defrost cycle to finish
<b>The temperature is too cold</b>	Controller is set at a very cold position	Set to warmer position and check if the compressor stops according to controllers operating range.
	Controller does not disconnect the condensing unit	Check the insulation of the thermostat. If problem persists, change the thermostat
	Control contacts are stuck closed	Change the control. Check amperage load
	Defective or incorrect temperature control	Determine correct control and replace.
<b>The temperature is not cold enough</b>	Controller is set at a very warm position	Adjust to colder setting
	Condenser is dirty	Clean condenser
	The refrigerator has been placed at an inadequate location	The unit must not be near stoves, walls that are exposed to the sun, or places that lack sufficient air flow.
	Compressor is inefficient or there is a high pressure due to the air in the system	If there is air in the system, purge and recharge
 	Iced up evaporator coil	Check temperature control, refrigerant charge, and defrost mechanism. Remove all ice manually and start over.
	Restriction in system	Locate exact point of restriction and correct
	The refrigerator has been used improperly	The shelves must never be covered with any type of plastic or other material that will block the circulation of cold air within the refrigerator.
	Too many door openings	Advise user to decrease if possible

		Excessive heat load placed in cabinet	Advise user not to put in products that are too hot.
		The refrigerator has been overcharged with the refrigerant gas	Check to see if condensation or ice crystals have formed on the suction line. If so, charge with the correct amount of gas.
		The refrigerant gas is leaking	Find the location of gas leak in order to seal and replace the defective component. Change the drier. Perform a good vacuum and recharge unit.
	 	The evaporator and/or condenser fans are not working	Check electrical connections and make sure that the fan blade isn't stuck. Replace the fan motor if it doesn't work.
		Blocking air flow	Re-arrange product to allow for proper air flow. Make sure there is at least four inches of clearance from evaporator.
		Fuse blown or circuit breaker tripped	Replace fuse or reset circuit breaker.
<b>Electrical Shocks</b>		Wires or electrical components are in direct contact with metallic parts.	Check for appropriate insulation on the connections of each component.
<b>Noise</b>		The refrigerator is not properly levelled	Check if the noise goes away after you level the refrigerator
		The condenser is not fastened correctly. Copper tubing is in contact with metal	While the compressor is working, check to see if metal parts are in contact with one another and/or if the screws that fasten the condenser are tightened.
		The evaporator and/or condenser fans are loose	Check if the fans are securely fastened. Also, check if the fan blades are loose, broken or crooked. If so, change the faulty blade.
		Compressor has an internal noise	If the noise persists after all other measures have been taken, it may be originating from the compressor.
		Loose part(s)	Locate and tighten loose part(s)
<b>Extreme condensation inside the refrigerator</b>		Controller is set at a very cold position	Set the controller to a warmer position & check to see if compressor stops as should.
		The outside environment's relative humidity is very high (over 75%)	This type of occurrence is caused by local climatic conditions and not by the refrigeration unit.
		The refrigerator door wont shut completely	Check the door and/or the magnetic gasket. Adjust the door hinges if needed; replace the gasket if broken.
		The refrigerator had been placed at an inadequate location	The unit must not be near sources that produce too much heat.
<b>No illumination (Glass door models only)</b>		The light switch is "off" position	Press the light switch to "on" position
		False contact on the light switch, the fluorescent tube, or the ballast	Inspect all connections
		Light switch, ballast and/or fluorescent tube are damaged	Replace the damaged component.

<b>Condensing unit runs for long periods of time</b>		Excessive amount of warm product placed in cabinet	Advise user to leave adequate time for products to cool down
		Prolonged door opening or door ajar	Advise user to ensure doors are closed when not in use and to avoid opening doors for long periods of time.
		Door gasket(s) not sealing properly	Ensure gaskets are snapped in completely. Remove gasket and wash with soap and water. Check condition of gasket & replace if necessary
		Dirty condenser coil	Clean condenser coil
		Evaporator coil iced over	Unplug unit and allow coil to defrost. Make sure thermostat is not set too cold. Ensure that door gasket(s) are sealing properly. Select manual defrost and ensure system works.

**Notes**



Foster European Operations

France

Foster Refrigerator France SA

Tel: (33) 01 34 30 22 22. Fax: (33) 01 30 37 68 74.

Email: [info@foster-fr.com](mailto:info@foster-fr.com)

Germany

Foster Refrigerator Gmbh,

Tel: (49) 781 990 7840. Fax (49) 781 990 7844.

Email: [info@foster-gmbh.de](mailto:info@foster-gmbh.de)

Foster Refrigerator

Oldmedow Road

Kings Lynn

Norfolk

PE30 4JU

Tel: 0843 216 8833

Fax: 0843 216 4707

Website: [www.fosterrefrigerator.co.uk](http://www.fosterrefrigerator.co.uk)

Email: [support@foster-uk.com](mailto:support@foster-uk.com)

a Division of 'ITW (UK) Ltd'

EPRO CAB/COUNT FD2-10/SM 04/11