

F20, F40, F60, F85
&
FCI20, FCI30, FCI40
FCI60, FCI85
Cube Ice Maker



Service Manual

Foster Ice Cuber Machine

CONTENTS	Page
1. General Information and Installation Instructions	2
1.1 Introduction	2
1.2 Unpacking and Inspection	2
1.3 Location and Leveling	2
1.4 Water Supply and Drain Connections	2-3
1.5 Final Checklist	3
1.6 Installation Practice	3
2. F20 and F40 Technical Data and Operating Instructions	4
3. F60 and F85 Technical Data and Operating Instructions	5-6
3.2 Cleaning/Rinsing For F20, F40, F60, F85	6
3.3 F20 F40, F60 F85, Wiring Diagrams	7
4. Technical Specification R22 Machines FCI 20, 30, 40, 60, 85	8
5. Operating Instructions	8-9
6. Principles of Operation	9-11
Wiring Diagrams	
7. Dip Switch Positions And Settings	12
Plus Dip Switch Settings for FCI 20,30, R134A Machines	
8. Circuit Board and Component Sequence of Operation	13
9. Technical Specification R134A Machines FCI 40,60,85	14
10. Operating Instructions	14-16
11. Principles of Operation	16-17
12. Components Description	17-18
13. Dip Switch Settings	18
14. Wiring Diagram	19
15. Circuit Board and Component Sequence of Operation	20
16. Maintenance and Cleaning Instructions All Models	21-22

1. General Information and Installation Instructions

1.1 Introduction

The Electronic Cubers are quality designed, engineered and manufactured.

Their ice making systems are thoroughly tested providing the utmost in flexibility to fit the needs of a particular user.

These icemakers have been engineered to our own rigid safety and performance standards.

The VDE – SEV – WRC seals signify that it is listed with them and that it complies with the materials and manufacturing standards of them.



Note. To retain the safety and performance built into this icemaker, it is important that installation and maintenance is conducted as outlined in this manual.

1.2 Unpacking and Inspection.

1. Visually inspect the exterior of the packaging and pallet. Report any damage to the delivery carrier and your distributor.
2.
 - a) Cut and remove the plastic strip securing the carton to the pallet.
 - b) Cut open the top of the carton and remove the polystyrene protection sheet.
 - c) Pull out the polystyrene posts from the corners and then remove the carton.
3. Remove the front and rear panels of the unit and inspect for any concealed damage. Report the damage to the distributor.
4. Remove all internal support packing and masking tape.
5. Check that refrigerant lines do not rub against or touch other lines or surfaces, and that the fan blade moves freely.
6. Use a clean damp cloth to wipe the surfaces inside the storage bin and the exterior of the cabinet.
7. See the data plate on the rear of the machine and check that the local mains voltage corresponds with the voltage specified on the plate.

CAUTION. INCORRECT VOLTAGE APPLIED TO THE MACHINE WILL INVALIDATE THE WARRANTY.

1.3 Location and Leveling.

Warning. This Ice Cuber is designed for indoor installation only. Extended periods of operation at temperatures exceeding the following limitations will constitute misuse under the terms of the Manufacturers Limited Warranty resulting in Loss of warranty coverage.

1. Position the machine in the selected permanent location. The criteria for the location includes:
 - a) Minimum room temperature 10°C (50°F) and maximum room temperature 40°C (100°F)
 - b) Water inlet temperatures: minimum 5°C (40°F) and maximum 40°C (100°F)
 - c) Well ventilated location for air cooled models. Clean the air cooled condenser at regular intervals.
 - d) Service access: adequate space must be left for all service connections through the rear of the ice maker. A minimum clearance of 15cm (6in) must be left at the sides of the machine for routing cooling air drawn into and exhausted out of the compartment to maintain proper condensing operation of the air cooled models.

NOTE. With the machine in 'built-in' conditions, the ice product is gradually reduced in respect of the levels shown in the table, up to a maximum of 10% at room temperatures higher than 32°C.

The daily ice-making capacity is directly related to the condenser air inlet temperature, water temperature and also the age of the machine.

To keep the **CUBER** at peak performance levels, periodic maintenance checks must be carried out as indicated in the Cleaning Section of this manual.

2. Level the unit in both left to right and front to rear directions.

3. ELECTRICAL CONNECTIONS.

See data plate for current requirements to determine wire size to be used on electrical connections. All ice makers require solid earth wire.

The 'F' series ice machines are supplied from the factory pre-wired and are fitted with a suitably fused thirteen Amp UK plug. The FCI models have a power cable that requires electrical connections to be made to the cable at the back of the machine, making sure that it is connected to its own circuit and individually fused (see data for the correctly fuse size).

The maximum allowable voltage variation should not exceed -10% and +6% of the data plate rating. Low voltage can cause faulty functioning and may be responsible for serious damage to the overload switch and motor windings.

NOTE. All external wiring should conform to national, state and local standards and regulations.

Check voltage on the line and the ice machines data before connecting the unit.

1.4 Water Supply and Drain Connections.

GENERAL.

When choosing the water supply for the ice cuber consideration should be given to:

- a) Length of run.
- b) Water clarity and purity.
- c) Adequate water supply pressure.

Since water is the most important single ingredient in producing ice you cannot emphasize too much the three items listed above.

Low water pressure below 1bar may cause the malfunction of the machine.

Water containing excessive minerals will tend to produce cloudy coloured ice cubes, plus scale build-up on parts of the water system

WATER SUPPLY.

Connect the male fitting of the solenoid water inlet valve, using the flexible tubing supplied, to the cold water supply line with regular plumbing

fittings and a shut off valve installed in an accessible position between the water supply line and the unit.

WATER SUPPLY - WATER COOLED MODELS.

The water cooled versions require two separate inlet water supplies on models 40 and 60, one to supply water for the ice production and one for the water cooled condenser.

Connect the male fitting of the condenser water inlet solenoid valve, using the second flexible tubing supplied, to the cold water supply line with regular plumbing fittings and a shut off valve installed in an accessible position between the water supply line and the unit.

WATER DRAIN.

The recommended drain tube is a plastic or flexible tube with 18mm (3/4in) I.D. that runs to an open trapped and vented drain. When the drain is along run, allow 3cm pitch per metre (1/4in per foot).

A vertical open vent, at the unit drain connection is also required for proper sump drainage.

WATER DRAIN – WATER COOLED MODELS.

The water drain line from the condenser, on water cooled versions, is internally connected with the drain fitting of the unit.

It is strongly recommended therefore to install a vertical open vent to the high point of the drain line high enough to ensure good drainage and to direct the drain line to a trapped and vented floor drain receptacle.

This ensures proper flow of the drained water as, in the case of poor drainage, the water running out of the condenser may leak through the unit drain tubing into the ice storage bin or into the sump reservoir.

NOTE. The water supply and the water drain must be installed to conform to the local codes. In some cases a licensed plumber and/or a plumbing permit is required.

1.5 Final Checklist.

1. Is the machine in a room where the ambient temperatures are within a minimum of 10°C (50°F) even in winter months?
2. Is there at least a 15cm (6in) clearance around the unit for proper air circulation?
3. Is the machine level? (IMPORTANT)
4. Have all the electrical and plumbing connections been made, and is the water supply shut-off valve open?
5. Has the voltage been tested and checked against the rating on the data plate?
6. Has the water supply pressure been checked to ensure a water pressure of at least 1 bar (14psi)?
7. Check all refrigerant lines and conduit lines to guard against vibration and possible failure?
8. Has the bin liner and cabinet been wiped clean?
9. Has the owner/user been given the User Manual and been instructed on the importance of periodic maintenance checks?
10. Has the owner/user been given the name and telephone number of the authorised Service Agency in case of breakdown.

1.6 Installation Practice.

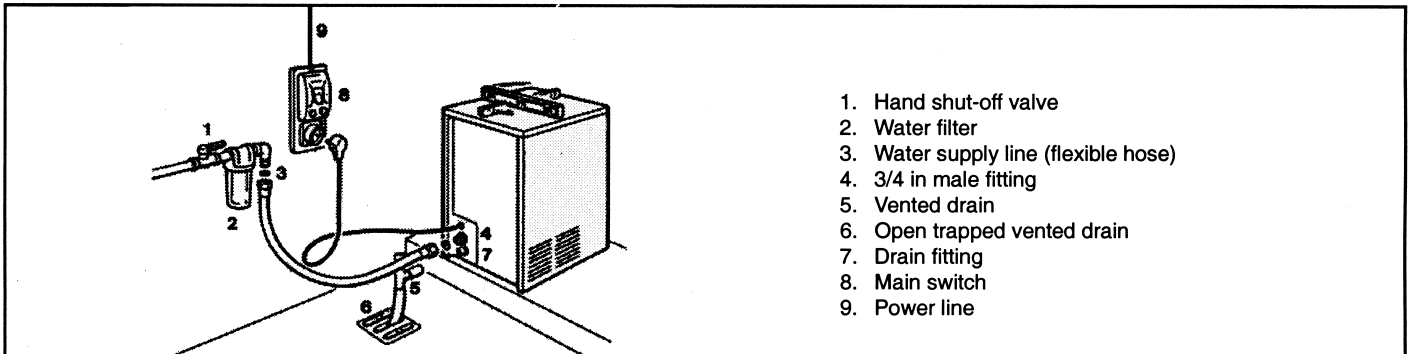

Warning. This ice maker is not designed for outdoor installation and will not function in ambient temperatures below 10°C (50°F) or above 40°C (100°F). The ice maker will malfunction with water temperature below 5°C (40°F) or above 40°C (100°F).

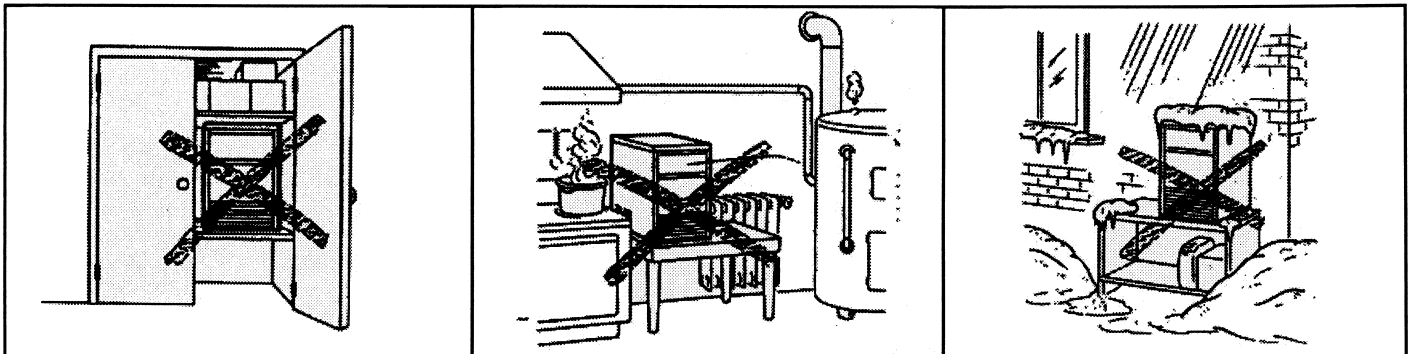

2. F20 and F40 Technical Data and Operating Instructions

2.1 Technical Data

Model	F20	F40
Output – kg/24hr	19.5	34.5
Bin storage capacity – kg	6.5	15
Cubes per cycle	16	24
Cubes kg per cycle	0.28	0.42
Cycle time – minutes	20.7	17.5
Amps start/run	11Amps/2Amps	17Amps/3.3Amps
Watts consumption (30°C Ambient Temp)	320w	450w
Water consumption (Water Temp at 15°C Ambient Temp 21°C)	8.5	8.5
Refrigerant	R134A	R134A
Refrigerant charge grams	250 grms	320 grms
Evaporator Temp with Gas Pressure at 10.5 Bar (Ambient Temp 21°C)	-7°C	-9°C
Evaporator Temp with Gas Pressure at 7.5 Bar (Ambient Temp 21°C)	-27°C	-24°C
Evaporator Temp with Gas Pressure at 13 Bar (Ambient Temp 32°C)	-5°C	-6°C
Evaporator Temp with Gas Pressure at 8 Bar (Ambient Temp 32°C)	-26°C	-24°C
Heat Emission, watts	540	850
Noise Level dBA at 2 meters	55dBA	58 dBA

2.2 Start Up

After having correctly installed the ice machine and completed the plumbing and electrical connections, perform the following “Start-up” procedure.

- A Switch on the power to the machine. The unit starts its first freezing cycle with the following components in operation:
COMPRESSOR
WATER PUMP
FAN MOTOR. (The condenser fan is controlled by a thermostat, factory set at approximately 33°C).
- B Check through the ice discharge opening that the spray plate is correctly seated and that the water jets uniformly reach the interior of the inverted cup molds; also make sure that the plastic curtain is hanging freely and that water is not spilling through it excessively.
- C The ice making process takes place thereby, the water is sprayed into the molds which gets gradually refrigerated by the heat exchanged with the refrigerant flowing into the evaporator serpentine.
- D When the evaporator temperature reaches a pre-set value the evaporator thermostat changes its contacts, the freezing cycle ends and the defrost/harvest cycle starts.
Freezing time will range between 17 and 22 minutes (depending on model, see table) in a 21°C ambient. Longer time for temperature above, shorter when below.
Average complete cycle range is about 17 to 25 minutes (depending on model, see table above)
- E Check, during the first defrost/harvest cycle, that the incoming water flows correctly into the sump reservoir in order to re-fill it and the surplus overflows down the overflow drain tube.
During this cycle the components energised are:
COMPRESSOR.
HOT GAS SOLENOID.
WATER INLET SOLENOID VALVE.
The FAN MOTOR and the WATER PUMP are also in operation if ambient temperature exceeds 33°C.
Note. During the defrost cycle, the water inlet solenoid valve is energised. The water flows through the valve to the back of the evaporator platen and then down to fill up the icemaker sump tank for the next freezing cycle.
- F Check the texture of the ice cubes just released. The correct size has a small depression (about 5-6mm) in their crown. If not, wait for the second defrost/harvest cycle before making any adjustments.

2.3 Adjustments

- G If after the second harvest the cubes are not correct adjustment to the evaporator thermostat may be necessary.
Remove the front panel and locate the cube size thermostat, using a flat bladed screwdriver turn towards the ‘+’ to increase the cube size and towards the ‘-’ to decrease the cube size. (See fig 1)
- H To check the bin full thermostat hold a handful of ice against the bulb of the storage bin thermostat, the ice maker will switch off in about one to two minutes.
Once the machine has stopped remove the ice and dispose of it, the machine will restart automatically in three to four minutes.
Note. The bin thermostat is factory set at 1°C (35°F) CUT OUT and 4°C (39°F) CUT IN. (The set temperature can be adjusted if required by using a flat bladed screwdriver turn towards the ‘+’ to increase the bin temperature and towards the ‘-’ to decrease the bin temperature). (See fig 1)
Refit the bottom front panel then instruct the owner/user on the general operation of the machine and about the cleaning and care it requires.
- I. The machine may stop working if the condenser temperature exceeds the pre-set temperature of the Over Temperature Thermostat (non-adjustable) due to a very high ambient temperature, condenser fan failure, dirty/ blocked condenser. To restart the machine depresses the protruding button on the Alarm Reset.

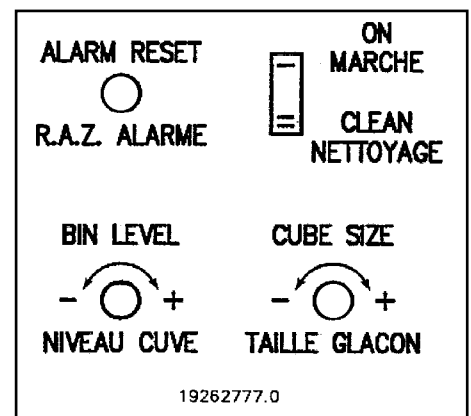

Fig. 1

3. F60 and F85 Technical Data and Operating Instructions

3.1 Technical Data

Model	F60	F85
Output – kg/24hr	60	83
Bin storage capacity – kg	27	27
Cubes per cycle	48	48
Cubes kg per cycle	0.84	0.84
Cycle time – minutes	19.0	15.5
Amps start/run	19/4.1	26/5.5
Watts consumption (30°C Ambient Temp)	630	780
Water consumption (Water Temp at 15°C Air Temp 21°C)	12.0	16.0
Refrigerant	R134A	R134A
Refrigerant charge grams	450 grms	540 grms
Evaporator Temp with Gas Pressure at 10.5 Bar (Ambient Temp 21°C)	-10°C	-26°C
Evaporator Temp with Gas Pressure at 7.5 Bar (Ambient Temp 21°C)	-6°C	-25°C
Evaporator Temp with Gas Pressure at 13 Bar (Ambient Temp 32°C)	-10°C	-28°C
Evaporator Temp with Gas Pressure at 8 Bar (Ambient Temp 32°C)	-7°C	-24°C
Heat Emission, watts	1100	1400
Noise Level dBA at 2 meters	60	63

3.2 Start Up

After having correctly installed the ice machine and completed the plumbing and electrical connections, perform the following “Start-up” procedure.

- A. Switch on the power to the machine. The unit starts its first freezing cycle with the following components in operation:
COMPRESSOR
WATER PUMP
FAN MOTOR. (The condenser fan is controlled by a thermostat, which is factory set).
- B. Check through the ice discharge opening that the spray plate is correctly seated and that the water jets uniformly reach the interior of the inverted cup molds; also make sure that the plastic curtain is hanging freely and that water is not spilling through it excessively.
- C. The ice making process takes place thereby, the water is sprayed into the molds which gets gradually refrigerated by the heat exchanged with the refrigerant flowing into the evaporator serpentine.
- D. When the evaporator temperature reaches a pre-set value (approximately -15°C) the evaporator thermostat changes its contacts and starts the time clock, when the first timed portion has elapsed the freezing cycle ends and the second timed portion starts the defrost/harvest cycle. Freezing time will range between 20 and 22 minutes (depending on model, see table) in a 21°C ambient. Longer time for temperature above, shorter when below.
Average complete cycle range is about 23 to 25 minutes (depending on model, see table above)
- E. Check, during the first defrost/harvest cycle, that the incoming water flows correctly into the sump reservoir in order to re-fill it and the surplus overflows down the overflow drain tube.
During this cycle the components energised are:
COMPRESSOR.
HOT GAS SOLENOID.
WATER INLET SOLENOID VALVE.
TIMER MOTOR
FAN MOTOR (if ambient temperature exceeds 30°C).

Note. During the defrost cycle, the water inlet solenoid valve is energised. The water flows through the valve to the back side of the evaporator platen and then down to fill up the icemaker sump tank for the next freezing cycle.

- C. Check the texture of the ice cubes just released. The correct size has a small depression (about 5-6mm) in their crown. If not, wait for the second defrost/harvest cycle before making any adjustments.

3.3 Adjustments

- G. If after the second harvest the cubes are not correct adjustment to the cube size thermostat may be necessary.
Using a flat bladed screwdriver turn towards the ‘+’ to increase the cube size and towards the ‘-’ to decrease the cube size. (See fig 2)
- H. To check the bin full thermostat hold a handful of ice against the bulb of the storage bin thermostat, the ice maker will switch off in about one to two minutes.
Once the machine has stopped remove the ice and dispose of it, the machine will restart automatically in three to four minutes.

Note. The bin thermostat is factory set at 1°C (35°F) CUT OUT and 4°C (39°F) CUT IN. (The set temperature can be adjusted if required by using a flat bladed screwdriver turn towards the ‘+’ to increase the bin temperature and towards the ‘-’ to decrease the bin temperature). (See fig 2)

Refit the bottom front panel then instruct the owner/user on the general operation of the machine and about the cleaning and care it requires.

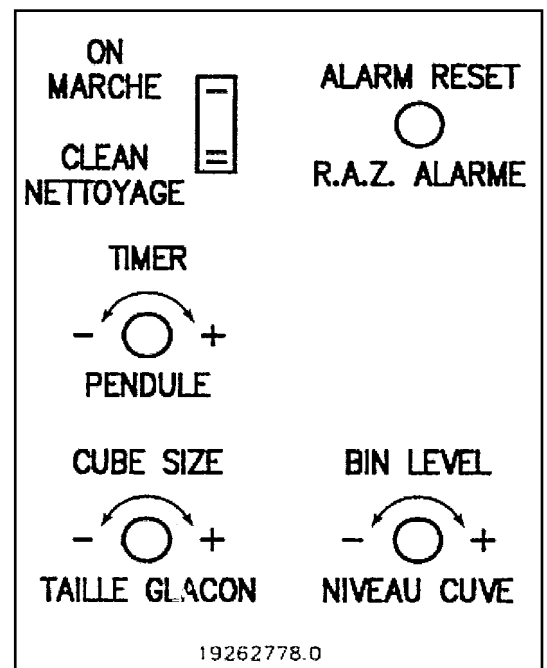

Fig 2

- I. The machine may stop working if the condenser temperature exceeds the pre-set temperature of the Over Temperature Thermostat (non-adjustable) due to a very high ambient temperature, condenser fan failure, dirty/ blocked condenser. To restart the machine, depress the protruding button on the Alarm Reset.
- J. Changes to the defrost time. Under normal circumstances no adjustments should be necessary. The fixed time can be adjusted by releasing the tension on the cam screw, turning the dial anti-clockwise to increase the defrost time and clockwise to decrease the defrost time, retighten the screw when the adjustment has been completed.
Note. If adjustment are made it will effect the freeze cycle.
Increasing the defrost time will shorten the freeze time so adjustments to the cube size thermostat may need to be made to increase the freeze temperature.
Decreasing the defrost time will increase the freeze time so adjustments to the cube size thermostat may need to be made to decrease the freeze temperature.

3.4 Cleaning/Rinsing For F20, 40, 60, 85

- A. Remove the bottom front panel and locate the changeover switch.
- B. Remove the top cover to gain access to the evaporator.
- D. Wait till the machine finishes its freeze cycle and then turn off the electrical supply to the machine.
- D. Prepare the cleaning solution as per the manufactures instructions on the Ice Machine Cleaner.
Warning. The Ice Machine Cleaner contains Phosphoric and Hydroxyacetic acids. These compounds are corrosive and may cause burns if swallowed. If swallowed DO NOT induce vomiting, drink lots of water or milk and contact your Doctor immediately.
In case of external contact wash off with clean water.
- E. Scoop out all of the ice cubes stored in the bin in order to prevent them from being contaminated by the cleaning solution then drain the water from the sump reservoir by removing the plastic overflow pipe. Once the water has drained from the sump replace the pipe.
- F. Remove the evaporator cover and slowly pour the solution onto the evaporator platen. Use a soft brush if necessary to remove stubborn deposits.
- G. Press the switch to the clean position and restore the electrical supply to the machine.
- H. Leave the machine in the cleaning/rinsing mode for at least twenty minutes then turn the machine off at the electrical supply to the machine. It may be necessary to clean the water spray separately. If required remove the spray plate from the machine, mix a solution of the cleaner in a bowl or bucket and immerse the plate in it. When clean thoroughly rinse with clean water and re-fit it into the machine.
- I. Drain the cleaning solution from the sump reservoir by removing the plastic overflow pipe. Once the solution has drained from the sump replace the pipe.
- J. Pour two to three litres of clean water over the evaporator platen to rinse of the remaining solution and ensure sufficient water is in the reservoir. Ensure that the switch is still in the 'CLEAN' position and turn on the electrical supply to the machine. Leave the machine in the cleaning mode for at least five minutes to thoroughly rinse the entire water system.
- K. Drain the rinsing water from the sump reservoir by removing the plastic overflow pipe. Once the rinsing water has drained from the sump replace the pipe and thoroughly wipe the interior of the machine.
- L. Replace the evaporator cover and top service panel, turn on the electrical supply to the machine with the switch still in the wash position. Leave the switch in this position for approximately five minutes to allow the water reservoir to fill up.
- M. Change the switch setting to the freeze position to start the freeze process.
- N. At the completion of the freezing and harvest cycle make sure the ice cubes are the proper texture and do not have an acid taste.
Attention. If the ice cubes are cloudy-white and have an acid taste, discard them immediately by pouring warm water over them to prevent them from being used.
- O. Once you are satisfied that all of the cleaning solution has been removed from the machine rinse the storage bin with clean water and wipe clean.
Remember. To prevent the accumulation of undesirable bacteria it is necessary to sanitize the interior of the storage bin with an anti-algae solution each week.

F20 & F40 A/W Wiring Diagram

WIRING DIAGRAM (MACHINE OPERATING)
SCHEMA ELETTRICO (MACCHINA IN FUNZIONE)

- G - GREY GRIGIO
- B - WHITE BIANCO
- N - BLACK NERO
- A - BLUE AZZURRO
- M - BROWN MARRONE
- GV - YELLOW GREEN GIALLO VERDE

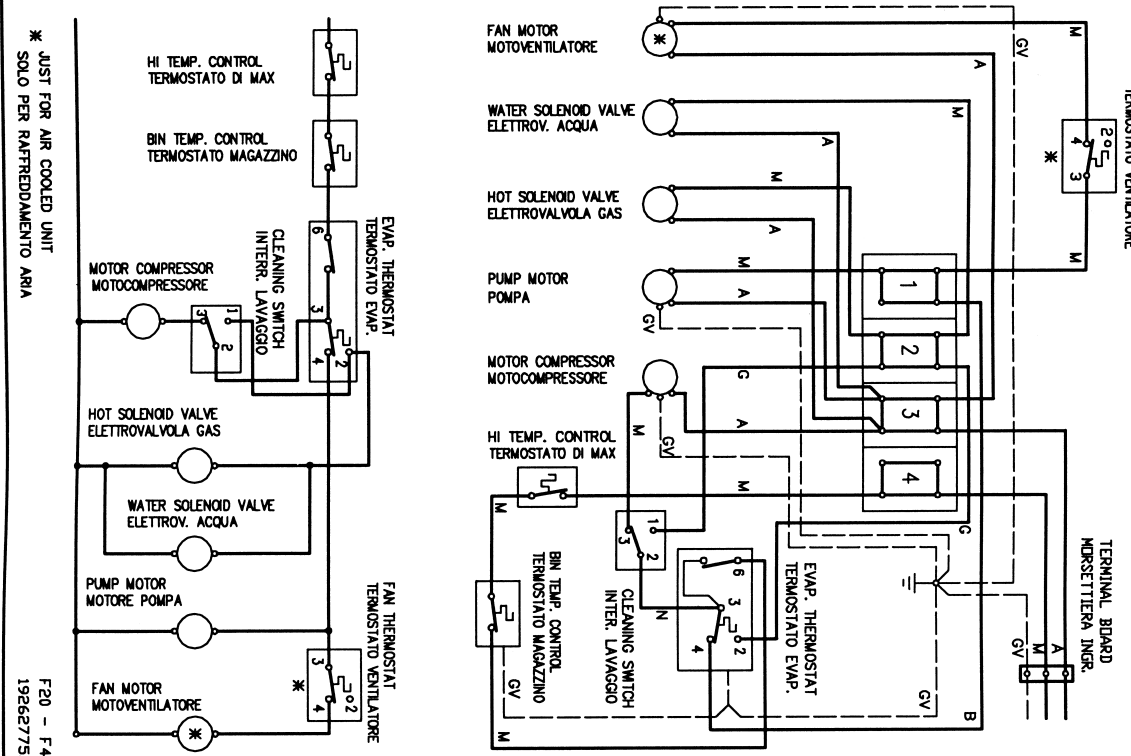

F60 & F85 A/W Wiring Diagram

WIRING DIAGRAM (MACHINE OPERATING)
SCHEMA ELETTRICO (MACCHINA IN FUNZIONE)

- A = AZZURRO-BLUE
- M = MARRONE-BROWN
- R = ROSSO-RED
- B = BIANCO-WHITE
- N = NERO-BLACK

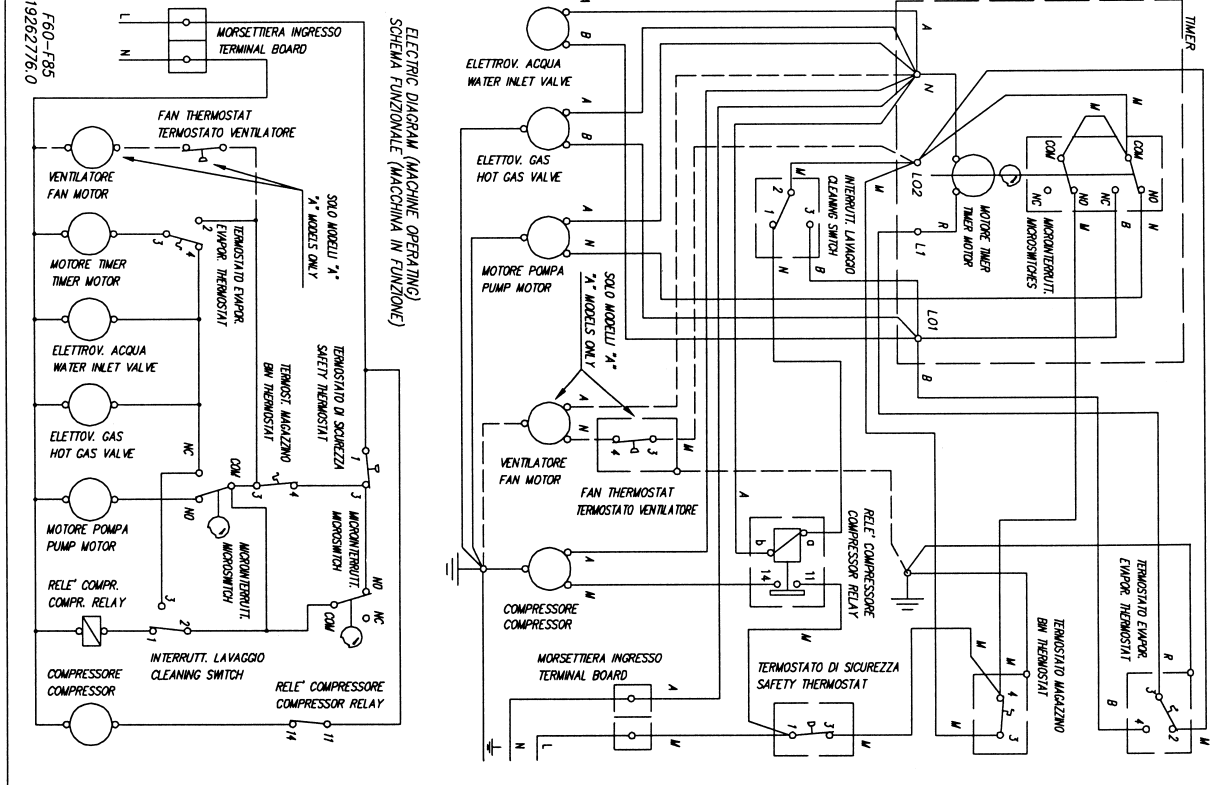

4. Technical Specification - R22 Machines

MODEL	FCI 20	FCI 30	FCI 40	FCI 60	FCI 85
Output – kg/24hr.	18 (20.5)	26 (34)	34 (42)	57 (70)	78 (90)
Bin storage capacity – kg	6.5	15	15	27	27
Cubes per cycle	16	24	24	48	48
kg per cycle	0.28 (0.38)	0.42 (0.6)	0.42 (0.6)	0.82 (1.2)	0.82 (1.2)
Cycle time – minutes	22 (25)	23.5 (24.5)	15.75 (19.15)	20.5 (23.6)	15.25 (18.75)
Amps start/run	9.5/1.9 (9.5/1.9)	11/2.2 (11/2.1)	16/3.3 (16/3.3)	16/3.5 (16/4)	24.5/4.4 (24.5/4)
Watts consumption	300 (280)	350 (330)	450 (450)	650 (650)	810 (760)
Water consumption	5.8lt/hr	5lt/hr	6.3lt/hr	12.5lt/hr	15.5lt/hr
Refrigerant	R22	R22	R22	R22	R22
Ref. charge, grams	300gr	280gr	290gr	420gr	460gr
Heat rejection, watts	500	600	850	1100	1600

5. Operating Instructions - R22 Machines

5.1 Start Up

After having correctly installed the ice maker and completed the plumbing and electrical connections, perform the following 'Start-up' procedure.

- A. Give power to the unit to start it up by switching 'ON' the power line main disconnect switch.
The **1st GREEN LED** will glow.

NOTE: Every time the unit returns under power, after having been switched off, both the water inlet valve and the hot gas valve get energised for a period of 5 minutes, thus to admit new water to the machine sump reservoir to fill it up and, eventually, to wash off any dirt that may be deposited in it during the unit off period (Fig. 1). Page 13

- B. During the water filling operation, check to see that the incoming water dribbles, through the evaporator platen dribbler holes, down into the sump reservoir to fill it up and also that the incoming surplus of water flows out through the overflow pipe into the drain line.

During the water filling phase the components energised are:

THE WATER INLET SOLENOID VALVE, THE HOT GAS SOLENOID VALVE, WATER DRAIN VALVE

NOTE: If in the 5 minutes length of the water filling phase the machine sump reservoir does not fill up to the rim of the overflow pipe, it is advisable to check:

1. The water pressure of the water supply line that must be at least 1 bar (14 psig) Minimum (Max 5 bar-70 psig).
2. The filtering device installed in the water line that may reduce the water pressure below the Minimum value of 1 bar (14 psig).
3. Any clogging situation in the water circuit like the inlet water strainer and/or the flow control.

5.2 Operational Checks

- C. At completion of the water filling phase (5 minutes) the unit passes automatically into the freezing cycle with the start up of: **COMPRESSOR WATER PUMP FAN MOTOR** in air cooled version (Fig. 2) Page 13 and the glowing of the **6th RED LED**.

- D. Check to see through the curtained ice discharge opening that the spray system is correctly seated and that the water jets uniformly reach the interior of the inverted mould cups; also make sure that the plastic curtain is hanging freely and there is no excessive water spilling through it.

- E. The ice making process takes place thereby, with the water sprayed into the moulds getting gradually refrigerated by the heat exchange occurring with the refrigerant flowing into the evaporator serpentine.

During the freezing process, when the evaporator temperature falls to 0°C (35°F) the evaporator temperature sensor, located in contact with the evaporator serpentine, supplies a low voltage power signal to the electronic control device (P.C. BOARD) which in first instance generates the glowing of the **5th RED LED** located in the front of the printed circuit board (Fig. 3). Page 13

- F. The unit remains however in its normal freezing cycle mode until the evaporator temperature detected by the sensor reaches the temperature of -13°C (8.5°F) on models 20, 30 40 and 60 and to -16°C (3°F) on model 85.

When the evaporator temperature falls below the above value, the evaporator temperature sensor supplies a low voltage power signal to the P.C. BOARD in order to activate the electronic timer. This takes over the control of the freezing cycle up to the complete formation of the ice cubes (Fig. 4) Page 13, with the lighting up of the **4th RED LED** located just above the previous lighted one.

NOTE The length of the entire freezing cycle is the sum of the lengths of three phases, two of which, **(T1 + T2) controlled** by the evaporator **temperature sensor**, which has its probe placed in contact with the evaporator serpentine (non adjustable), and ONE. **(Ta) by the electronic timer** (Adjustable) incorporated in the P.C. BOARD.

The lengths of the first two phases, related to the evaporator temperature and controlled by its sensor, are:

T1 - The time elapsed since the beginning of freezing cycle up to when the evaporator reaches the temperature of **0°C (35°F)**.

T2 - The time required for the evaporator to fall from **0°C (35°F)** to **-13°C (8.5°F)** or to **16°C (3°F)**.

The third time **Ta** - Time added - is in relation to one of the different combinations of the five keys **3,4,5, 6, and 7 of the DIP SWITCH** located in the front of the P.C. BOARD. The combination is factory set in consideration of the ice maker type and of its cooling version. It is possible, however, to vary the timed length of the freezing cycle, by changing the **DIP SWITCH** keys settings.

In Table B are shown the various time extensions of the freezing cycle third phase **Ta**, in relation with the different **DIP SWITCH** keys settings.

- G. After about 20-22 minutes from the beginning of the freezing cycle, in a hypothetic ambient temperature of 21°C (70°F), the defrost cycle takes place with the hot gas and the water inlet valves being simultaneously activated (Fig. 5). Page 13

The electrical components in operation in this new situation are:

NOTE: The length of the defrost cycle is (non-adjustable) automatically determined by the microprocessor of The P.C. BOARD in relation to the time T2 necessary for the unit to reduce the evaporator temperature from 0°C (35°F) to -1.3°C (8.5°F) and of the ambient temperature, as illustrated in Table C.

As shown it is possible to have a different length of the defrost cycle in connection with the different length of the second phase of the freezing cycle T2 relative to the ambient temperature situations; shorter when the ambient temperature is high and longer in colder ambients so to partially compensate the length of the freezing cycle, which is longer in high ambient temperatures and shorter in low ones.

- H. Check, during the defrost cycle, that the incoming water flows correctly into the sump reservoir in order to refill it and that its surplus overflows through the overflow drain tube.
- I. Check the texture of ice cubes just released. They have to be the right shape with a small depression of about 5-6mm in their crown. If not, wait for the completion of the second cycle before performing any adjustment. If the ice cubes require a correction to their shape, it is possible to modify the length of the timed freezing cycle by changing the **DIP SWITCH** keys setting as illustrated in table B. If the ice cubes are shallow and cloudy, it is possible that the ice maker runs short of water during the freezing cycle second phase or, the quality of the supplied water requires the use of an appropriate water filter or conditioner or the installation of the optional water drain valve kit KWD.
- J. To be sure of the correct operation of the ice level temperature sensor, located in one side of storage bin liner, during the defrost cycle place one shovel of ice cubes in contact with its probe for approx. 30 sec.-1 minute. As the temperature of storage bin sensor reaches the value of +2°C (35°F), the ice level control transmits a signal to the microprocessor of the P.C. BOARD in order to stop the ice maker operation at the end of the defrost cycle with the simultaneous glowing of the **3rd RED LIGHT**, to monitor the **BIN FULL** situation (Fig.6). Page 13
With no more ice cubes in touch with the ice level control the temperature of its probe progressively rises to reach + 4.5°C (40°F) and at this point the ice machine restarts to initiate a new freezing cycle with the simultaneous extinguishing of the **3rd RED LIGHT**.

NOTE The **CUT-IN RANGE OF THE ICE LEVEL CONTROL SENSOR** can be adjusted as shown in table D; its cut out setting remains however at + 2°C (35°F).

6. Principle of Operation

6.1 How it works

In the cube ice makers the water used to make the ice is kept constantly in circulation by an electric water pump which primes it to the spray system nozzles from where it is diverted into the inverted mould cups of the evaporator. A small quantity of the sprayed water freezes into ice; the rest of it cascades by gravity into the sump assembly below for recirculation.

6.2 Freezing Cycle

The hot gas refrigerant discharged out from the compressor reaches the condenser where, being cooled down, condenses into liquid. Flowing into the liquid line it passes through the drier filter, then it goes all the way through the capillary tube where, due to the heat exchanging action, it loses some of its heat content so that its pressure and temperature are lowered as well.

Next the refrigerant enters into the evaporator serpentine (which has a larger I.D. than the capillary) and starts to boil off; this reaction is emphasised by the heat transferred by the sprayed water.

The refrigerant then increases in volume and changes entirely into vapour.

The vapour refrigerant then passes through the suction accumulator (used to prevent any small amount of liquid refrigerant reaching the compressor) and through the suction line. In both the accumulator and the suction line it exchanges heat with the refrigerant flowing into the capillary tube (warmer), before being sucked into the compressor and recirculated as hot compressed refrigerant gas.

The freezing cycle is controlled by the evaporator temperature sensor (which has its probe in contact with the evaporator serpentine) which determines the length of the first and second portion of it and it is signalled by the glowing of the **6th RED LED**.

The first portion length or time **T1** (non-adjustable) is equal to the time required by the temperature sensor to fall to **0°C (35°F)**. When reached, it is signalled by the glowing of the **5th RED LED**.

NOTE If, after **15 minutes**, the evaporator temperature has not yet reached the value of **0°C (35°F)** (due to a partially or total shortage of refrigerant or to a too high condensing temperature, etc.) the sensor, through the P.C. BOARD, causes the unit to stop the operation with the simultaneous glowing of the **SECOND RED WARNING LED** (Fig. 7). Page 13. After having eliminated the source of the unit trip off, to restart the machine operation it is necessary first to rotate the program selector to the **RE-SET** position, then put it again on to **OPERATION** position or, alternatively, switch OFF and ON the unit at the power line Main Switch.

The **second portion** length of freezing cycle or time **T2** (non-adjustable) is equal to the time required by the evaporator temperature to go from **0°C (35°F) to -13°C (8.5°F) on models 20, 30, 40 and 60** or to **-16°C (3°F) on model 85**. The sensor will light-up the **4th RED LED**.

NOTE In case the time **T2** gets **longer than 45 minutes**, the unit stops with the glowing of the **second RED WARNING LED**.

Also in this case, after having eliminated the source of the trip OFF to restart the machine it is necessary first to rotate the program selector to the **RESET** position then put it again on **OPERATION** or, switch OFF and ON the unit at power line Main Switch.

The **third portion** or time **Ta** (added time) of the freezing cycle is controlled by the electronic timer of P.C. BOARD. As the evaporator temperature reaches the value of **-13°C (8.5°F)** or to **-16°C (3°F)**; the sensing probe of the evaporator sensor (in contact with the serpentine) changes its electrical resistance causing a low voltage current to flow to the P.C. BOARD which, thereby, activates an **electronic timer**.

NOTE The activation of the timer (Time mode) of P.C. BOARD is signalled by the glowing of **fourth RED LED** located in the front of the P.C. BOARD.

ATTENTION In case the length of the second portion of freezing cycle or time **T2**, lasts as long as between **35 and 45 minutes**, the third portion or time **Ta** gets skipped by the P.C BOARD which puts the unit directly in the defrost or harvest cycle.

The length of the third portion of the freezing cycle (adjustable) is pre-fixed and related to the setting of the **DIP SWITCH** keys 3, 4, 5, 6 and

7. The DIP. SWITCH keys setting is made in consideration of the model and of the type of condenser used (air or water cooled). In Table B, page 12, are indicated the various lengths of the third portion of freezing cycle (Time mode) in accordance with the different combinations of the DIP. SWITCH KEYS.

In Table A, page 12, are indicated the DIP. SWITCH keys combinations for the different models and versions as they are set in the factory.

The electrical components in operation during the freezing cycle are:

COMPRESSOR

FAN MOTOR (in air cooled version)

WATER PUMP and during the timed phase of freezing cycle (Time mode) they are joined by the ELECTRONIC TIMER.

On the air cooled versions the refrigerant head pressure is gradually reduced from a value of approx. **15 bars (210psig)**, generally recorded at the beginning of the freezing cycle with the unit at 21°C (70°F) ambient temperature, to a minimum value of approx. **11 bars (155psig)** just at the end of the freezing cycle a few seconds before the starting of the defrost cycle.

The above values are in relation as well to the ambient temperature of the ice maker site and are subject to rise with the increase of this temperature.

On the water cooled versions the refrigerant head pressure ranges between **13.5 and 14.5 bars (190-205psig)** being controlled by the automatic high pressure control that energises a water solenoid valve located on the inlet water line to the condenser, which modulates the cooling water rate to the condenser.

With the unit installed in standard location (21°C ambient temperature) at the start of the freezing cycle the refrigerant suction or low-pressure lowers rapidly to **3.5 bars (50psig)** then declines gradually, in relation with the growing of the ice thickness, to reach, at the end of the cycle approx. **1.0 to 1.3 bars (14-18psig)** on 20,30 and 65 and at approx. **0.6 bars (8.5psig)** on 40 with the cubes fully formed in the cup moulds.

6.2 Defrost or Harvest Cycle

As the electronic timer has carried the system throughout the third phase of freezing cycle or as soon as the second phase **T2** is over (when its length has been as long as 35 to 45 minutes) the defrost cycle starts.

NOTE: The length of the defrost cycle (non-adjustable) is related to the length of the second phase of freezing cycle **T2** as detailed in Table C. Page 12.

The electrical components in operation during this phase are:

COMPRESSOR

WATER INLET SOLENOID VALVE

HOT GAS SOLENOID VALVE

The incoming water, passing through the water inlet valve and its flow control, runs over the evaporator platen and then flows by gravity through the dribbler holes down into the sump / reservoir.

The overflow, located in the sump tank, limits the level of the water which will be used to produce the next batch of ice cubes.

Meanwhile, the refrigerant as hot gas, discharged from the compressor, flows through the hot gas valve directly into the evaporator serpentine bypassing the condenser.

The hot gas circulating in the serpentine of the evaporator warms up the copper moulds causing the ice cubes to defrost. The ice cubes, released from the cups, drop by gravity onto a slanted cube chute, then through a curtained opening fall into the storage bin.

At the end of the defrost cycle, both the hot gas and the water inlet valves close and the machine starts again a new freezing cycle.

6.3 Operation - Control Sequence

At the start of freezing cycle the **evaporator temperature sensor** controls the length of the first **T1** and second **T2** portion of the freezing cycle. As it senses the predetermined evaporating temperature of -13°C (8.5°F) (-16°C on 85) it supplies a low voltage current to the P.C. BOARD in order to activate the electronic timer which takes over the control of the remaining portion of the freezing cycle for a pre-fixed time **Ta** subject to the DIP SWITCH keys setting (see Table B). Page 12.

NOTE: The evaporator temperature sensor, factory pre-set, is the same for all models and is not adjustable in the field.

During the normal operation mode the length or the total time of the freezing cycle is equal to the sum of the three partial times i.e.:

$$T_c = T_1 + T_2 + T_a$$

In case the length of the second portion of the freezing cycle or time **T2** gets long as to be between 35 and 45 minutes, the total length of the freezing cycle will be limited to:

$$T_c = T_1 + T_2$$

skipping the added time **Ta**, controlled by the electronic timer.

If instead the time **T2** gets longer than 45 minutes the unit stops immediately with the lighting up of the warning **RED LIGHT**.

The same could happen in case the time **T1** (1st portion of freezing cycle) gets longer than 15 minutes.

Once completed the freezing cycle 2nd or 3rd phase (this last one is dependent on the length of the second phase of freezing cycle - **T2**) the system goes automatically into the defrost cycle **Ts**.

The defrost cycle also has a prefixed length that can vary in relation to the time **T2**, as shown in Table C.

At completion of the defrost cycle the P.C. BOARD puts the unit into a new freezing cycle.

6.4 Components Description

A. EVAPORATOR TEMPERATURE SENSOR

The evaporator temperature sensor probe, located in contact with the evaporator serpentine, detects the dropping of the evaporator temperature during the freezing cycle and signals it by supplying a current flow to the microprocessor of The P.C. BOARD.

According to the current signal and to how long after this is received, the microprocessor may or not give the consent to the ice maker to complete the freezing cycle.

The low voltage current transmitted, from the evaporator temperature sensor to the P.C. BOARD, is signalled by the lighting up of the **fourth (Time T2)** and **fifth (Time T1) RED LEDS** placed in the front of the P.C. BOARD to inform the service engineer, of the normal (regular) progression of the freezing cycle.

B. ICE BIN LEVEL SENSOR

The ice bin level temperature sensor, secured to one of the storage bin walls, stops the operation of the entire ice maker at the end of the defrost cycle when its sensing probe (in contact with the stored ice) reaches the temperature of +2°C (35°F) lighting up, in the meantime, the third **RED LED**.

Once the ice is removed from the sensing probe, its temperature progressively rises up and as it reaches the value of +4.5°C (40°F) the ice bin level temperature sensor transmits a low voltage current flow to the P.C. BOARD to restart the operation of the unit.

NOTE: The ice maker, after the interruption of its operation due to the ice level control cut-out, always restarts from the beginning of the freezing cycle.

By changing the combination of the **DIP SWITCH Keys numbers 8 and 9** it is possible to change the range of the ice level control temperature sensor. This is shown in table D, keeping its cut out temperature always at +2°C (35°F).

C. P.C. BOARD (Data processor)

The P.C. BOARD, fitted in its plastic box located in the front of the unit, consists of two separated printed circuits one at high and the other at low voltage integrated with a program selector; of six aligned **LEDS** monitoring to the service engineer the operation of the machine; of one **DIP SWITCH** with ten keys; of input terminals for the leads of the two sensor probes and of input and output terminals for the leads of the ice maker electrical wires.

The P.C. BOARD is the brain of the system and it processes, through its microprocessor, the signals received from the two sensors in order to control the operation of the different electrical components of the ice maker (compressor, water pump, solenoid valves, etc.).

By turning the program selector it is possible to put the unit in the following different situations:

CLEANING/RINSING The water pump is the only electrical component in operation and it must be used during the cleaning or the rinsing procedure of the water system of ice machine.

STAND BY The unit remains under electrical power but OUT of operation. It can be used by the service engineer in order to stop the unit during the service and inspection operations.

IN OPERATION The unit is running through the freezing and defrost cycles stopping automatically only at full bin situation.

RE-SET To be selected to resume the unit operation when the ice maker shuts off due to the intervention of the security of the P.C. BOARD in relation to exceeding the time of freezing cycle portion T1 and T2.

The six LEDS (not visible through the panel) placed in a vertical row in the front of the P.C. BOARD, monitor, from the top to the bottom, the following situations:

GREEN LIGHT Unit under electrical power

RED LIGHT Unit shut-off due to P.C. BOARD security (T1 >15' or T2>45')

RED LIGHT Unit shut-off at full storage bin

RED LIGHT Evaporator sensor at -13°C (85°F) or -16°C (3°F)

RED LIGHT Evaporator sensor at 0°C (35°F)

RED LIGHT Unit in freezing cycle mode

The microprocessor of the P.C. BOARD has also the important function to establish the length of the defrost cycle **Ts** in relation with the duration of the second phase of the freezing cycle or time **T2** as shown in Table B. Page 12.

6.5 Dip Switch

The P.C. BOARD which controls the entire operation of the ice maker, has a **DIP SWITCH with ten switching keys** which allow set up of the microprocessor program in order to extend or to shorten the length of freezing cycle in relation to the different models and versions of ice machines and to modify the sensing range of the ice bin level temperature sensor.

The 1st DIP SWITCH key is used to supply power to the water pump during the first 15-20 seconds of the defrost cycle to pump out all remaining water from the sump tank in the unit along with the water drain valve.

The 2nd DIP SWITCH key allows a rapid check up (auto-diagnosis) to be made of the P.C. BOARD output connections (compressor, water pump, fan motor, water inlet and hot gas solenoid valves) energising them in rapid sequence (2 seconds) one by one.

DURING THE AUTOMATIC OPERATION OF THE ICE MAKER THIS KEY MUST BE SET IN OFF POSITION.

ATTENTION The check up of the P.C. BOARD output must be performed in a very short time in order to avoid frequent start and stop (every few seconds) of the electrical components which may damage them - especially the compressor.

The **setting of the DIP SWITCH keys 3, 4, 5, 6 and 7** determines the length of the 3rd phase of freezing cycle (controlled by the electronic timer) as detailed in Table B. Page 12.

The **DIP SWITCH keys 8 and 9** setting determines the range between cut in and cut out temperature of the ice bin level temperature sensor as specified in Table D. Page 12.

The 10th DIP SWITCH key is used to change the setting of the evaporator temperature sensor from -13°C (8.5°F) - **OFF position** (20,30,40 and 60 to -16°C (3°F) - **ON position** on model 85.

7. Dip Switch Positions

Table A

DIP SWITCHES	FCI 20	FCI 30	FCI 40	FCI 60	FCI 85
1	ON	ON	ON	ON	ON
2	OFF	OFF	OFF	OFF	OFF
3	ON	OFF	ON	ON	ON
4	OFF	OFF	OFF	ON	ON
5	ON	ON	ON	ON	ON
6	OFF	OFF	OFF	OFF	OFF
7	ON	ON	ON	ON	ON
8	OFF	OFF	OFF	OFF	OFF
9	OFF	OFF	OFF	OFF	OFF
10	OFF	OFF	OFF	OFF	ON

Table B

LENGTHS OF TIMED PORTION OF FREEZING CYCLE Ta ACCORDING TO THE DIP SWITCH SETTING COMBINATIONS					
3	4	5	6	7	Ta min.
ON	ON	ON	ON	ON	0
OFF	ON	ON	ON	ON	1
ON	OFF	ON	ON	ON	2
OFF	OFF	ON	ON	ON	3
ON	ON	OFF	ON	ON	4
OFF	ON	OFF	ON	ON	5
ON	OFF	OFF	ON	ON	6
OFF	OFF	OFF	ON	ON	7
ON	ON	ON	OFF	ON	8
OFF	ON	ON	OFF	ON	9
ON	OFF	ON	OFF	ON	10
OFF	OFF	ON	OFF	ON	11
ON	ON	OFF	OFF	ON	12
OFF	ON	OFF	OFF	ON	13
ON	OFF	OFF	OFF	ON	14
OFF	OFF	OFF	OFF	ON	15
ON	ON	ON	ON	OFF	16
OFF	ON	ON	ON	OFF	17
ON	OFF	ON	ON	OFF	18
OFF	OFF	ON	ON	OFF	19
ON	ON	OFF	ON	OFF	20
OFF	ON	OFF	ON	OFF	21
ON	OFF	OFF	ON	OFF	22
OFF	OFF	OFF	ON	OFF	23
ON	ON	ON	OFF	OFF	24
OFF	ON	ON	OFF	OFF	25

Table C

LENGTH OF THE DEFROST CYCLE Ts ACCORDING TO THE TIME OF T2	
T2	Ts
T2 < 5'	210"
5' < T2 < 6'	195"
6' < T2 < 6'30"	180"
6'30" < T2 < 7'	165"
7' < T2 < 8'	150"
8' < T2 < 9'	135"
9' < T2 < 10'30"	120"
10'30" T2 < 12'	105"
12' < T2	90"

Table D

ICE LEVEL SENSOR CONTROL TEMPERATURE RANGE ACCORDING TO THE 8 AND 9 DIP SWITCH SETTING COMBINATIONS		
8	9	DELTA T °C
ON	ON	1
OFF	ON	1.5
ON	OFF	2
OFF	OFF	2.5

Dip Switch Settings FCI 20 and FCI 30 - R134A Machines
IT IS IMPORTANT TO NOTE THAT THE OPERATING INSTRUCTION AND PRINCIPLE OF OPERATION FOR THE FCI 20 AND FCI 30 ARE THE SAME AS THE R22 MACHINES

Dip switch	1	2	3	4	5	6	7	8	9	10
FCI 20	ON	OFF	OFF	ON	ON	OFF	ON	OFF	OFF	ON
FCI 20 W	ON	OFF	OFF	ON	ON	OFF	ON	OFF	OFF	ON
FCI 30	ON	OFF	OFF	OFF	OFF	ON	ON	OFF	OFF	ON
FCI 30 W	ON	OFF	OFF	OFF	OFF	ON	ON	OFF	OFF	ON

8. Circuit Board and Component Sequence of Operation

Fig. 1

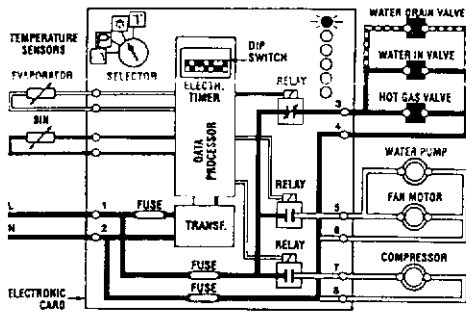

START UP

Fig. 2

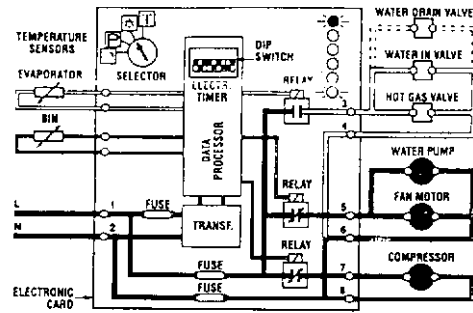

START OF FREEZE CYCLE

Fig. 3

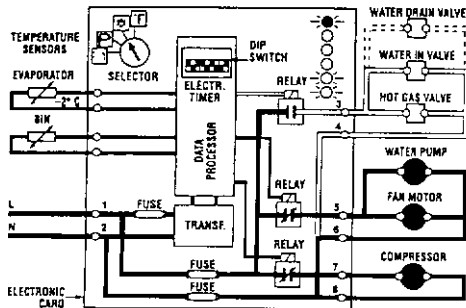

PHASE 2 OF FREEZE CYCLE

Fig. 4

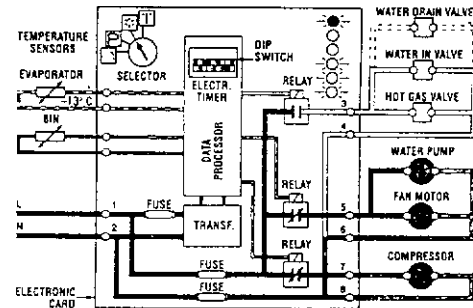

PHASE 3 OF FREEZE CYCLE

Fig. 5

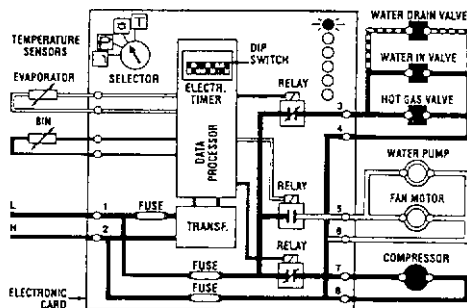

DEFROST CYCLE

Fig. 6

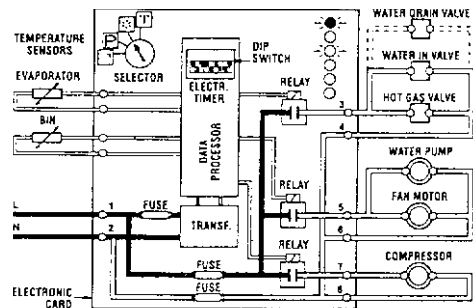

BIN FULL

Fig. 7

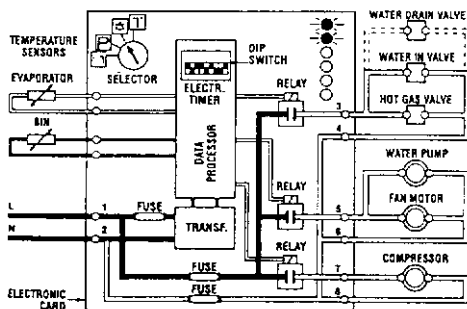

MACHINE FAULT RED LED ILLUMINATED

Fig. 8

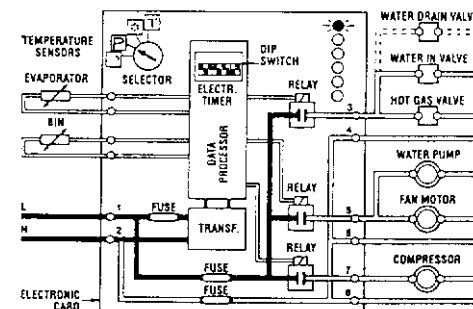

STAND BY

Fig. 9

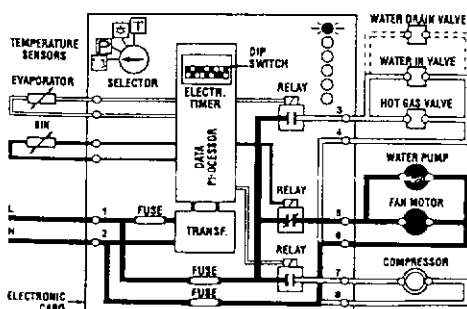

9. Technical Specification - R134A Machines

MODEL	FCI 20	FCI 30	FCI 40	FCI 60	FCI 85
Output – kg/24hr.	18	26	34	57	76
Ice prod. per cycle	0.28kg	0.42kg	0.42kg	0.86kg	0.86kg
Freeze time cycle	19.5 min	21.2 min	16 min	19.5 min	14.5 min
Cubes per cycle	16	24	24	48	48
Bin capacity kg	6.5	15	15	27	27
Electrical Supply	230/1/50 Hz	230/1/50 Hz	230/1/50 Hz	230/1/50 Hz	230/1/50 Hz
Amp start / run	11amp/2amp	11amp/2.2amp	17amp/3.3amp	19amp/4.1amp	26amp/5.5amp
Fuse rating	10A	10A	10A	10A	16A
Watts consumption (30°C ambient)	320	340	450	630	780
Water consumption	7.5 litre per hr	5.6 litre per hr	6.2 litre per hr	11.0 litre per hr	14.5 litre per hr
Min evap Temp °C	-26°C	-26°C	-26°C	-26°C	-26°C
Heat rejection watts	0.540	0.580	0.850	1.1	1.4
Noise level dBA	< 70 dB	< 70 dB	< 70 dB	< 70 dB	< 70 dB

R134A Ice Machines Technical Data (air cooled)

Model	Refrig. & Charge	Start Cycle 21°C amb/15°C w		End Cycle 21°C amb/15°C w		Start Cycle 32°C amb/15°C w		End Cycle 32°C amb/15°C w	
		Cond (bar)	Evap (°C)	Cond (bar)	Evap (°C)	Cond (bar)	Evap (°C)	Cond (bar)	Evap (°C)
FCI 20	R134A 0.250kg	10	-7	6.5	-27	13	-5	8	-26
FCI 30	R134A 0.230kg	12	-5	7	-26	16.5	-2	9.5	-24
FCI 40	R134A 0.320kg	11	-9	8.5	-26	14	-6	9.5	-24
FCI 60	R134A 0.450kg	11	-8	8.5	-27	14	-6	9	-25
FCI 85	R134A 0.540kg	11	-8	8	-26	15	-6	9.5	-24

10. Operating Instructions - FCI 40 - 60 - 85 Only (For FCI 20-30 see previous section)

10.1 Start Up

After having correctly installed the ice maker and completed the plumbing and electrical connections, perform the following “Start-up” procedure.

- A. Remove the unit front panel and locate the control box.
- B. Through the control box cover locate the grooved head (similar to a fillister screw head) of the electronic program selector. With the help of a regular screwdriver turn the selector head in the **OPERATION** position. (The screwdriver bit must fit the head slot end to end, this to avoid damage to the selector head slot).
- C. Give power to the unit to start it up by switching ‘ON’ the power line main disconnect switch.

NOTE: Every time the unit returns under power, after having been switched off, both the water inlet valve and the hot gas valve get energized for a period of 5 minutes, thus to admit new water to the machine sump reservoir to fill it up and, eventually, to wash-off any dirt that can have deposited in it during the unit off period (Fig.1).

- D. During the water filling operation, check to see that the incoming water dribbles through the evaporator platen dribbler holes, down into the sump reservoir to fill it up and also that the incoming surplus of water flows out through the overflow pipe into the drain line. During the water filling phase the components energized are:

THE WATER INLET SOLENOID VALVE
 THE HOT GAS SOLENOID VALVE
 THE WATER DRAIN SOLENOID VALVE
 (On request)

NOTE: If in the 5 minutes length of the water filling phase the machine sump reservoir does not get filled with water up to the rim of the overflow pipe, it is advisable to check:

1. The water pressure of the water supply line that must be at least 1 bar (14 psig) Minimum (Max 5 Bar-70 psig).
2. The filtering device installed in the water line that may reduce the water pressure below the Minimum value of 1 bar (14 psig).
3. Any clogging situation in the water circuit like the inlet water strainer and/or the flow control.

- E. At completion of the water filling phase (5 minutes) the unit passes automatically into the freezing cycle with the start up of:
COMPRESSOR
WATER PUMP
FAN MOTOR (in air cooled version) controlled by the condensing temperature sensor located within the condenser fins (Fig.2). Page 20.

10.2 Operational Checks

- F. Install, if necessary, the refrigerant service gauges on both the high side and low side Schröder valves to check the compressor head and suction pressures.

NOTE: On air cooled models, the condenser temperature sensor, which is located within the condenser fins, keep the head (condensing) pressure between 13,5 and 14,5 bars (190-205 psig).

In the water cooled models the discharge pressure is kept constant at the value of 14 bars (195 psig) by means of the water regulating valve located in the water supply line to the condenser.

In case of condenser clogging such to prevent the proper flow of the cooling air or fan motor out of operation, the condenser temperature rises and when it reaches 70°C (160°F) the condenser temperature sensor shuts-off the ice maker with the consequent light-up of the **RED WARNING LIGHT** (Fig.3). Page 20.

The same happen even for the water cooled version where the condenser probe is placed in contact with the refrigerant liquid line.

When its temperature reaches 62°C (145°F) it trips-off automatically the machine.

After having diagnosed the reason of the rise in temperature and removed its cause, it is necessary to turn the head of the selector - always using an appropriate screwdriver - first on the **RE-SET** position then return it on previous **OPERATION** position, thus to put the machine in condition to initiate a new freezing cycle.

The same can also be done by just switching OFF and ON the unit at main line switch.

In both cases the machine restarts with the usual 5 minutes water filling phase in order to provide enough water into the sump tank.

- G. Check to see through the ice discharge opening that the spray systems are correctly seated and that the water jets uniformly reach the interior of the inverted mould cups; also make sure that the plastic curtain is hanging freely and there is no excessive water spillage through it.

- H. The ice making process takes place thereby, with water sprayed into the moulds that gets gradually refrigerated by the heat exchange with the refrigerant flowing into the evaporator serpentine.

During the freezing process, when the evaporator temperature falls below an established value, the evaporator temperature sensor supplies a low voltage power signal to the electronic control device (P.C. BOARD) in order to activate an electronic timer. This one takes over the control of the freezing cycle up to the complete formation of the ice cubes (Fig.4) Page 20.

NOTE: The length of the entire freezing cycle is governed by the evaporator temperature sensor which has its probe placed in contact with the evaporator serpentine (Non adjustable) in combination with the electronic timer (Adjustable) incorporated in the P.C. BOARD. The timer adjustment is factory set in consideration of cooling version and ice cube size (Medium, Large).

It is possible, however, to modify the timed length of the freezing cycle, by changing the **DIP SWITCH** keys setting.

In Table B, Page 18 are shown the various time extensions of the freezing cycle second phase, in relation with the different DIP SWITCH settings.

- I. After about 15-18 minutes from the beginning of the freezing cycle, in an hypothetic ambient temperature of 21°C, the defrost cycle takes place with the hot gas and the water inlet valves being simultaneously activated (Fig.5). Page 20. The electrical components in operation are:

COMPRESSOR

WATER INLET SOLENOID VALVE

HOT GAS VALVE

and, if installed

WATER DRAIN SOLENOID VALVE

NOTE: The length of the defrost cycle is determined by the DIP SWITCH keys setting in conjunction with the ambient temperature sensor located just in front of the condenser. The length of defrost cycle can be adjusted by changing the combination setting of keys 5, 6 and 7 of **DIP SWITCH** as illustrated on Table C. Page 18.

As shown, per each individual key combination, it is possible to have a different length of the defrost cycle in relation to the different ambient temperature situations; shorter when the ambient temperature is high and longer in colder ambient's to partially compensate for the length of the freezing cycle, which is longer in high ambient temperatures and shorter in low ones.

- J. Check, during the defrost cycle, that the incoming water flows correctly into the sump reservoir in order to refill it and that the surplus overflows through the overflow drain tube.

- K. Check the texture of ice cubes just released. They have to be in the right shape with a small depression of about 5-6mm in their crown.

If not, wait for the completion of the second cycle before performing any adjustment.

If required, the length of the timed freezing cycle can be modified by changing the DIP SWITCH keys setting as illustrated in Table B Page 18.

If the ice cubes are shallow and cloudy, it is possible that the ice maker runs short of water during the freezing cycle second phase or, the quality of the supplied water requires the use of an appropriate water filter or conditioner.

- L. To be sure of the correct operation of ice level control device, place one hand between its sensing "eyes" to interrupt the light beam.

The **RED LIGHT** located in the front of the P.C. BOARD goes immediately OFF, and after 60 seconds, the unit stops with the simultaneous glowing of the **2nd YELLOW LIGHT** to monitor the **BIN FULL** situation (Fig.6) Page 20.

Take the hand out from the ice level control sensors to allow the resumption of the light beam; the **RED LIGHT**, located in the front of the P.C. BOARD, will glow immediately.

After approximately 6 seconds the ice maker resumes its operation with the immediate glowing of the **FOURTH YELLOW LIGHT** indicating **UNIT IN OPERATION** and the extinguishing of the **"BIN FULL" YELLOW LIGHT**.

NOTE: The ICE LEVEL CONTROL (INFRARED SYSTEM) is independent from the temperature however, the reliability of its detection can be affected by external light radiation's or by any sort of dirt and scale sediment which may deposit directly on the light source and on the receiver. To prevent any possible ice maker malfunction, due to negative affection of the light detector, it is advisable to locate the unit where it is not reached by any direct light beam or light radiation, also it is recommended to keep the bin door constantly closed and to follow the instructions for the periodical cleaning of the light sensor elements as detailed in the MAINTENANCE AND CLEANING PROCEDURES.

- M. Remove, in installed, the refrigerant service gauges and re-fit the unit service panels previously removed.

11. Principle of Operation

11.1 How it works

In the cube ice makers the water used to make the ice is kept constantly in circulation by an electric water pump which primes it to the spray system nozzles from where it is diverted into the inverted mould cups of the evaporator. A small quantity of the sprayed water freezes into ice; the rest of it cascades by gravity into the sump assembly below for recirculation.

11.2 Freezing Cycle

The Hot refrigerant gas discharged out from the compressor reaches the condenser where, being cooled down, condenses into liquid. Flowing into the liquid line it passes through the drier filter, then it goes all the way through the capillary tube where, due to the heat exchanging action, it loses some of its heat content so that its pressure and temperature are lowered as well.

Next the refrigerant enters into the evaporator serpentine (which has a larger I.D. than the capillary) and starts to boil off; this reaction is emphasized by the heat transferred by the sprayed water.

The refrigerant then increases in volume and changes entirely into vapour.

The refrigerant vapour then passes through the suction accumulator (used to prevent any small amount of liquid refrigerant from reaching the compressor) and through the suction line. In both the accumulator and the suction line it exchanges heat with the refrigerant flowing into the capillary tube (warmer), before being sucked in the compressor and to be recirculated as high pressure, high temperature gas.

The freezing cycle is controlled by the evaporator temperature sensor (which has its probe in contact with the evaporator serpentine) that determines the length of the cycle first portion.

When the temperature of the evaporator serpentine drops to a pre-set value, the evaporator sensor probe changes its electrical resistance allowing a low voltage current (8-10 volts) to flow to the P.C. BOARD which in turn activates an electronic timer.

The timer, which is built-in the P.C. BOARD, takes over, from the evaporator temperature sensor, the control of the freezing cycle up to its completion.

NOTE: The change of the electrical potential of the evaporator sensor with the consequent activation of the timer (Time mode) is signalled by the glowing-up of the **RED LED** located in the front of the P.C. BOARD.

ATTENTION: In case, after 15 minutes from the beginning of the freezing cycle, the temperature of the evaporator sensor probe is higher than 0°C (32°F) (Shortage of refrigerant, inoperative hot gas valve, etc.) the P.C. BOARD switch OFF immediately the unit with the simultaneous blinking of the **WARNING RED LED**.

The length of the second portion of the freezing cycle is pre-fixed and related to the setting of the first four DIP SWITCH keys which is made in relation with the different unit versions.

The DIP SWITCH keys setting is made in consideration of the type of condenser used.

In Table B, page 18, are indicated the various lengths of the second portion of freezing cycle (Time mode) in relation to the different combinations of the DIP SWITCH KEYS.

In Table A, page 18, is illustrated the DIP SWITCH keys combinations for the different unit versions as they are set in the factory.

The electrical components in operation during the freezing cycle are:

COMPRESSOR

FAN MOTOR (in air cooled version)

WATER PUMP

CONTACTOR COIL

and during the second phase of freezing cycle (Time mode) they are joined by the

ELECTRONIC TIMER

The refrigerant head pressure, in the course of the freezing cycle, ranges between 13.5 and 14.5 bars (190-205 psig) being controlled by the temperature sensor probe located within the condenser fins (Air cooled version) or, it is kept constant at 14 bars (195 psig) by means of the water regulating valve (water cooled version).

On the air cooled version, the condenser temperature sensor, when senses a rising of the condenser temperature beyond the pre-fixed limit, changes its electrical resistance and send a low voltage power signal to the Micro Processor of P.C. BOARD which in turn energizes, through a **TRIAC**, the **FAN MOTOR**.

When the opposite situation occurs, i.e. the condenser temperature gets below the pre-fixed limit, the temperature sensor changes again its electrical resistance reducing therefore the current flow to the P.C. BOARD to cause the fan motor to temporary cut-off.

NOTE: In case the condenser temperature probe senses that the condenser temperature has risen to 70°C (160°F) - on air cooled versions - or 62°C (145°F) - on water cooled versions - for one of the following abnormal reasons:

CLOGGED CONDENSOR (Air cooled version)

FAN MOTOR OUT OF OPERATION (Air cooled version)

INSUFFICIENT FLOW OF COOLING WATER (Water cooled version)

AMBIENT TEMPERATURE HIGHER THEN 40°C (100°F)

it causes the total and immediate SHUT-OFF of the machine in order to prevent the unit from operating in abnormal and dangerous conditions.

When the ice maker stops on account of this protective device, there is a simultaneous glowing of the **RED LED**, warning the user of the Hi Temperature situation. After having eliminated the source of the condenser hi-temperature, to restart the machine it is necessary first, to rotate for a while the program selector on **RE-SET** position then, to rotate it again on OPERATION position.

The same can be done by just switching OFF and ON the unit at main line switch.

The ice machine resumes its normal operation by going through the 5 minutes water filling phase.

At the start of the freezing cycle the refrigerant suction or lo-pressure lowers rapidly to 3.3 bar-45 psig then it declines gradually - in relation with the growing of the ice thickness - to reach, at the end of the cycle, approx. 1 bar -14 psig with the cubes fully formed in the cup moulds.

The total length of the freezing cycle ranges from 15-18 minutes.

11.3 Defrost or Harvest Cycle

As the electronic timer has carried the system throughout the second phase of freezing cycle, the defrost cycle starts.

ATTENTION: In case the unit is be able to reach 0°C (32°F) evaporating temperature within 15 minutes, or after 45 minutes from the beginning of the freezing cycle it has not yet reached the evaporator temperature of -15°C (5°F), the machine goes straight into the defrost cycle omitting the timed portion of the freezing cycle related to the setting of the first four DIP SWITCHES.

NOTE: The length of the defrost cycle is pre-determined by the setting of the DIP SWITCH KEYS NO. 5, 6 and 7 and it is related as well to the

ambient temperature as detailed in Table C. Page 18.

The electrical components in operation during this phase are:

COMPRESSOR

WATER PUMP

WATER INLET SOLENOID VALVE

HOT GAS SOLENOID VALVE

The incoming water, passing through the water inlet valve and the flow control, runs over the evaporator platen and then flows by gravity through the dribbler holes down into the sump/reservoir.

The water filling the sump/reservoir forces part of the surplus water from the previous freezing cycle to go out to the waste through the overflow pipe. This overflow limits the level of the sump water which will be used to produce the next batch of ice cubes.

Meanwhile, the high pressure, high temperature refrigerant, discharged from the compressor, flows through the hot gas valve directly into the evaporator serpentine by-passing the condenser.

The hot gas circulating into the serpentine of the evaporator warms up the copper moulds causing the defrosting of the ice cubes. The ice cubes, released from the cups, drop by gravity onto a slanted cube chute, then through a curtained opening they fall into the storage bin.

NOTE: The length of the defrost cycle, factory set, can vary in accordance with the actual ambient temperature (as shown on Table C). Page 18. For instance, in a high ambient temperature situation it can be reduced to recover some of the time spent for the longer freezing cycle.

At the end of the defrost cycle, both the hot gas and the water inlet valves close, so the machine initiates another freezing cycle.

11.4 Operation - Control Sequence

At the start of the freezing cycle, the evaporator **temperature sensor** controls the length of the first part of the freezing cycle. As it reaches a pre-determined temperature, it supplies a low voltage current to the P.C. BOARD in order to activate the **electronic timer** which takes over the control of the freezing cycle for a pre-fixed time according to the DIP SWITCH keys setting (see Table B). Page 18.

NOTE: The evaporator temperature sensor, factory pre-set, is the same for all the models and is not adjustable in the field.

Once completed the freezing cycle 2nd phase the system goes automatically into the defrost cycle which has also a pre-fixed length that can vary depending upon the actual ambient temperature as shown in Table C. Page 18.

At completion of the defrost cycle the P.C. BOARD command the unit to start again a new freezing cycle.

12. Components Description

12.1 Evaporator Temperature Sensor

The evaporator temperature sensor probe, located in contact with the evaporator serpentine detects the dropping of the evaporator temperature during the freezing cycle and signals it by supplying a current flow to the micro processor of the P.C. BOARD.

According to the current received, the evaporator sensor supplies power to the P.C. BOARD first, when it reaches 0°C (32°F), second at -15°C (5°F); in this second case its supply power to the electronic timer built into the P.C. BOARD so that it may take control of the length of the 2nd phase of freezing cycle.

The length of the timed phase is pre-fixed by the setting of the keys 1, 2, 3 and 4 of the DIP SWITCH.

The activation of the electronic timer (-15°C -5°F) is monitored by the lighting up of the RED LED placed in the front of the P.C. BOARD. This lighting up occurs usually in the mid period of the freezing cycle and signals the switching from the first to the second phase of the freezing cycle.

12.2 Condenser Temperature Sensor

The condenser temperature sensor probe, located within the condenser fins (air cooled version) or in contact with the tube coil (water cooled version) detects the condenser temperature variations and signals them by supplying current, at low voltage, to the P.C. BOARD.

In the air cooled versions, in relation to the different current received, the micro processor of the the P.C. BOARD supplies, through a TRIAC, the power at high voltage to the fan motor so to cool the condenser and to reduce its temperature rises and reaches 75°C (170°F) the current arriving to the micro processor is such to cause an immediate and total stop of the machine operation.

12.3 Ambient Temperature Sensor

The probe of this sensor, located in the front of the ice maker condenser (air cooled version) and in the water supply line to the condenser (water cooled version) has the function to detect the ambient or the water temperature and, by changing its own electrical resistance, supplies a different current flow to the P.C. BOARD.

This different current flow received by the P.C. BOARD, is processed by the micro processor in order to extend or shorten the defrost cycle length (longer in cold ambient situations, shorter in warm ones).

12.4 Ice Bin Level Light Control

The electronic ice bin level control, located into the storage bin, has the function to stop the operation of the ice machine when the light beam between the light source and the sensor is interrupted by the ice cubes stored in the bin. When the light beam is interrupted the RED LED located in the front of the P.C. BOARD goes off; in case the light beam is constantly interrupted for more than 60 seconds, the ice machine stops with the glowing-up of the 2nd YELLOW LED to monitor the situation of ice bin full. The 60 seconds of delay prevent that an ice scoop movement or the ice dropping through the ice chute (interrupting for a while the light beam) can stop the operation of the unit.

As soon as the ice is scooped out (with the resumption of the light beam between the two infrared sensor of ice level control) the RED LED is lighted up and after 6 seconds the ice machine restarts again with the extinguishing of the 2nd YELLOW LED.

12.5 E.P.C. Board (Data processor)

The P.C. BOARD, fitted in its plastic box located in the front of the unit, consists of two separated printed circuits one at high and the other at low voltage integrated with a program selector, of two fuses one on power in (100m A) and one on power out (16 A) of five aligned **LEDS** monitoring the operation of the machine, of two extra monitoring **RED LEDS**, of one **DIP SWITCH** with ten keys, of two small plugs located on its back side, of input terminals for the leads of the sensor probes and input and output terminals for the leads of the ice maker electrical wires. The P.C. BOARD is the brain of the system and it processes, through its micro processor, the signals received from the four sensors in order to control the operation of the different electrical components of the ice maker (compressor, water, pump, solenoid valves, etc.).

By turning the program selector it is possible to put the unit in the following different situations.

CLEANING/RINSING: The water pump is the only electrical component in operation and it must be used during the cleaning or the rinsing procedure of the water system of ice machine.

STAND BY: The unit remain under electrical power but OUT of operation. It can be used by the service engineer in order to stop the unit during

the service and inspection operations.

IN OPERATION: The unit is running through the freezing and defrost cycle stopping automatically only at full bin situation.

RE-SET/HI TEMPERATURE: To be selected to resume the unit operation when the ice maker shuts off due to the intervention of the condenser temperature sensor (too high condensing temperature).

The five LEDs, placed in a row in the front of the P.C. BOARD, monitor the following situations:

GREEN LIGHT: Unit under electrical power

YELLOW LIGHT: Unit shut-off at full storage bin

RED LIGHT: Unit shut-off due to hi-condensing temperature

Blinking: Unit shut-off due to hi-evaporating temperature

YELLOW LIGHT: Unit in freezing operation

YELLOW LIGHT: Unit in cleaning/rinsing mode

12.6 DIP SWITCH

The P.C. BOARD which controls the entire operation of the ice maker, has a **DIP SWITCH with ten switching keys** which allow to set up the micro processor program in order to extend or to shorten the length of freezing and defrost cycles in relation to the different models and versions of ice machines.

The DIP SWITCH first four keys setting determines the length of the 2nd phase of freezing cycle (controlled by the electronic timer) as detailed in Table B.

The DIP SWITCH keys 5, 6 and 7 setting determines the length of the defrost cycle according to the ambient temperature sensor as specified in table C.

The 8th DIP SWITCH key allows to make a rapid check up of the P.C. BOARD output connections (compressor, water pump, fan motor, water inlet and hot gas solenoid valves) energizing them in rapid sequence (2 seconds) one by one.

DURING THE AUTOMATIC OPERATION OF THE ICE MAKER THIS KEY MUST BE SET IN OFF POSITION.

ATTENTION: The check up of the P.C. BOARD output must be performed in a very short time in order to avoid frequent starts and stops (every few seconds) of the electrical components which may damage them, especially the compressor.

The 9th key allows the operation of the water pump even during the defrost cycle. On **B 90** it must be set all the time to **OFF** position.

The 10th key is used to supply power to the water pump during the first 15-20 seconds of the defrost cycle to drain out all remaining water from the sump tank in the unit equipped with the solenoid drain valve i.e. the KWD drain system.

13. Dip Switch Settings FCI 40-60-85

Table A

Dip switch	1	2	3	4	5	6	7	8	9	10
FCI 40	ON	ON	OFF	ON	ON	ON	OFF	OFF	ON	OFF
FCI 40 W	ON	ON	OFF	ON	ON	ON	OFF	OFF	ON	OFF
FCI 60	ON	ON	OFF	ON	ON	ON	OFF	OFF	ON	OFF
FCI 60 W	ON	ON	OFF	ON	ON	ON	OFF	OFF	ON	OFF
FCI 85	OFF	OFF	ON	ON	ON	ON	OFF	OFF	ON	OFF
FCI 85 W	OFF	OFF	ON	ON	ON	ON	OFF	OFF	ON	OFF

Table B

LENGTH OF TIMED PORTION OF FREEZING CYCLE ACCORDING TO DIP SWITCH COMBINATIONS											
	1	2	3	4			1	2	3	4	
1	ON	ON	OFF	OFF	25 min	8	OFF	ON	OFF	ON	11 min
2	OFF	OFF	ON	OFF	23 min	9	ON	ON	OFF	ON	9 min
3	ON	OFF	ON	OFF	21 min	10	OFF	OFF	ON	ON	7min
4	OFF	ON	ON	OFF	19 min	11	ON	OFF	ON	ON	5 min
5	ON	ON	ON	OFF	17 min	12	OFF	ON	ON	ON	3 min
6	OFF	OFF	OFF	ON	15 min	13	ON	ON	ON	ON	1 min
7	ON	OFF	OFF	ON	13 min						

Table C

LENGTH OF DEFROST CYCLE (IN SEC.) ACCORDING TO THE AMBIENT TEMPERATURE AND TO DIP SWITCH SETTING COMBINATIONS											
5	6	7	0-5°C	5-10°C	10-15°C	15-20°C	20-25°C	25-30°C	30-35°C	35-40°C	
ON	ON	OFF	180 sec	150 sec	120 sec	90 sec	90 sec	90 sec	90 sec	90 sec	
OFF	OFF	ON	210 sec	180 sec	150 sec	120 sec	120 sec	120 sec	90 sec	90sec	
ON	OFF	ON	240 sec	210 sec	180 sec	150 sec	150 sec	120 sec	120 sec	90 sec	
OFF	ON	ON	240 sec	210 sec	180 sec	150 sec	150 sec	120 sec	120 sec	120 sec	
ON	ON	ON	270 sec	240 sec	210 sec	180 sec	180 sec	150 sec	150 sec	150 sec	

14. Wiring Diagram

WIRING DIAGRAM - SCHEMA ELETTRICO SCHÉMA ÉLECTRIQUE - SCHALTUNGSCHEMA

AIR & WATER COOLED - RAFFREDDAMENTO AD ARIA ED AD ACQUA.
REFROIDISSEMENT A AIR ET A EAU - LUFT UND WASSERGEKÜHLT

220-240/50/1

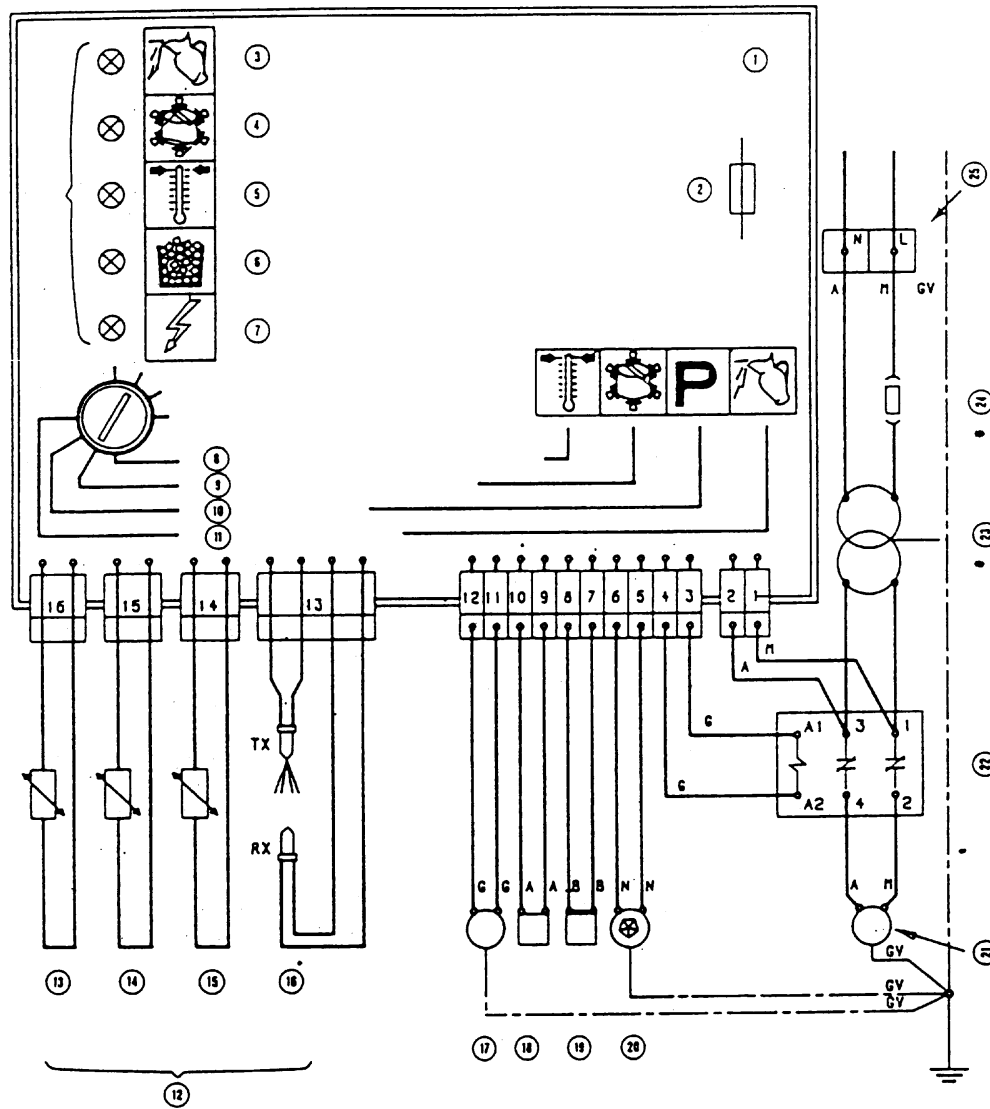

- | | | |
|---------------------------|-----------------------------|------------------------|
| (1) Printed Circuit Board | (10) Stand By | (19) Water Inlet Valve |
| (2) Fuse | (11) Rinsing | (20) Fan Motor |
| (3) Rinsing | (12) Sensors | (21) Compressor |
| (4) Freezing Oper. | (13) Evaporator Temperature | (22) Contactor |
| (5) Too High Temperature | (14) Condenser Temperature | (23) Autotransformer |
| (6) Bin Full | (15) Ambient Temp. | (24) Fuse |
| (7) Power On | (16) Ice Level Sensor | (25) Terminal Board |
| (8) Reset to High Temp. | (17) Water Pump | |
| (9) Freezing Oper. | (18) Hot Gas Valve | |

15. Circuit Board and Component Sequence of Operation

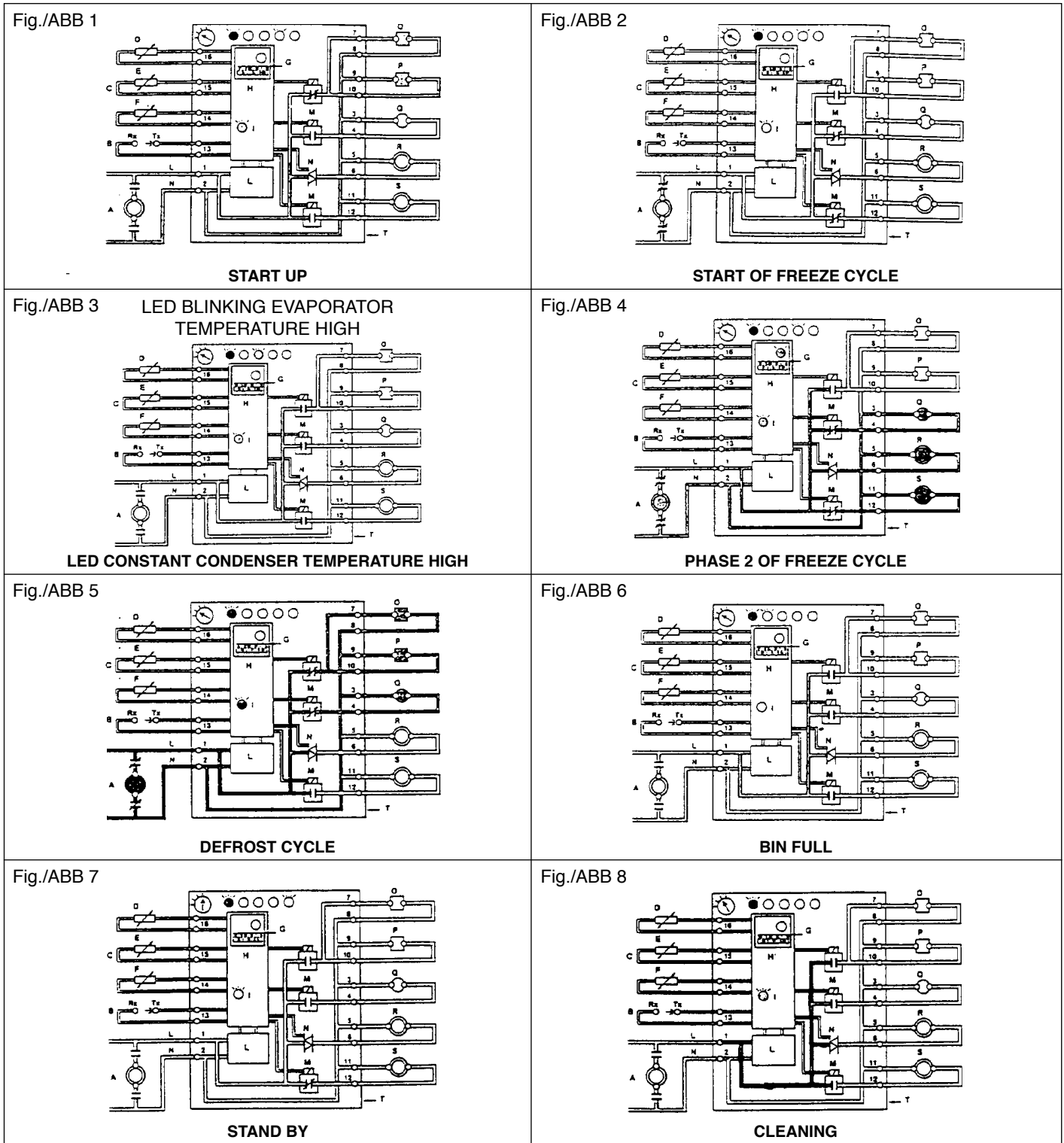

- | | | | | | |
|-----|-------------------|-----|-----------------|-----|-------------------|
| (A) | COMPRESSOR | (G) | DP SWITCH | (O) | WATER INLET VALVE |
| (B) | ICE LEVEL SENSOR | (H) | ELECTRIC TIMER | (P) | HOT GAS VALVE |
| (C) | SENSORS | (I) | MICRO PROCESSOR | (Q) | CONTRACTOR COIL |
| (D) | EVAP. TEMPERATURE | (L) | TRANSFORMER | (R) | FAN MOTOR |
| (E) | COND. TEMPERATURE | (M) | RELAY | (S) | WATER PUMP |
| (F) | AMBIENT TEMP. | (N) | TRIAC | (T) | P.C. BOARD |

16. Maintenance and Cleaning Instructions

16.1 General

The periods and the procedures for maintenance and cleaning are given as guides and are not to be construed as absolute or invariable. Cleaning, especially, will vary depending upon local water and ambient conditions and the ice volume produced; and, each ice maker must be maintained individually, in accordance with its particular location requirements.

16.2 Icemaker

The following maintenance should be scheduled at least twice per year on these ice makers.

1. Check and clean the water line strainer.
2. Check that the ice maker is levelled side to side and in front to rear directions.
3. Clean the water system, the evaporator, the bin and spray platen using a solution of Ice Machine Cleaner.
Refer to procedure 15.3 cleaning instructions and after cleaning will indicate frequency and procedure to be followed in local areas.

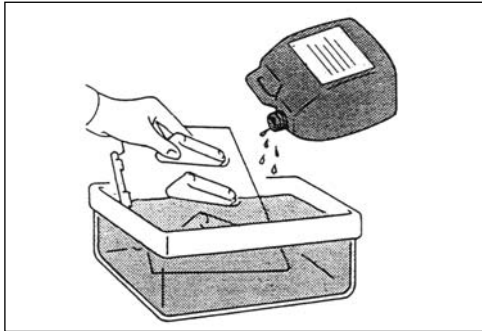

NOTE Cleaning requirements vary according to the local water conditions and individual user operation. Continuous check of the clarity of ice cubes and visual inspection of the water spraying parts before and after cleaning will indicate frequency and procedure to be followed in local areas.

4. With the ice machine and fan motor OFF on air cooled models, clean condenser using vacuum cleaner, soft brush or non metallic brush.
5. Check for water leaks and tighten drain line connections. Pour water down bin drain line to be sure that drain line is open and clear.
6. Check size, condition and texture of ice cubes. Perform adjustment of **DIP SWITCH** keys as required.
7. Check the ice level control sensor to test shut-off.
Put a shovelful of ice cubes in contact with the control sensor during the defrost cycle.
This should cause the ice maker to shut off at the end of the defrost cycle and the light up the **3rd RED LED**.
Within a few seconds after the removal of the shovelful of ice from the sensing probe, the ice maker restarts in freezing cycle.

NOTE The RANGE OF THE ICE LEVEL CONTROL SENSOR can be adjusted as shown on table D of PRINCIPLE OF OPERATION; its cut out setting remains however at +2°C (35°F).

8. Check for refrigerant leaks.

16.3 Cleaning Instructions of Water System

1. Remove the rear and top panels to gain access either to the control box or to the evaporator.
2. Wait till the end of defrost cycle then, with the help of a normal screwdriver, turn the program selector head on **STAND BY** position to temporarily stop the operation (Fig. 10). + (Fig. 8) (R134A Machines Fig. 7).

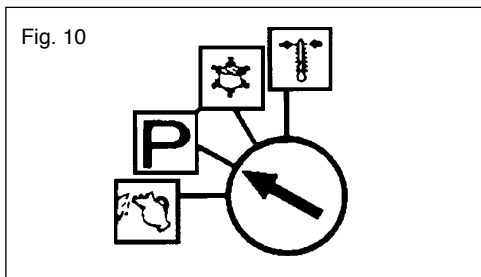

3. Prepare the cleaning solution by diluting in a plastic container one or two litres of warm water (45-50°C) with 0.1-0.2 litres of Ice Machine Cleaner.

WARNING The Ice Machine Cleaner contain: Phosphoric and Hydroxyacetic acids.

These compound: are corrosive and may cause burns if swallowed, DO NOT induce vomiting. Give large amount: of water or milk. Call Physician Immediately.

In case of external contact flush with water.

KEEP OUT OF THE REACH OF CHILDREN.

4. Scoop out all the ice cubes stored into the bin in order to prevent them from being contaminated with the cleaning solution then flush out the water from the sump reservoir by removing the plastic plug.
5. Remove the evaporator cover then slowly pour onto the evaporator platen the cleaning solution. With the help of a brush dissolve the most resistant and remote scale deposits in the platen.
6. Set the program selector head on **CLEANING/RINSING** (Fig. 11) + (Fig. 9).

Fig. 11

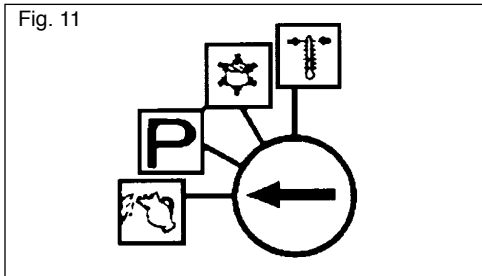

6. (R134A Machines Fig. 8)

NOTE With the system in **CLEANING/RINSING** mode the water pump is the only component in operation to circulate the cleaning solution in the entire water system.

7. Let the unit remain in the **CLEANING/RINSING** mode for about 20 minutes then turn the program selector on **STAND BY** again.
8. Flush out the cleaning solution from the sump reservoir then pour onto the evaporator cavity two or three litres of clean potable water to rinse the mould cups and the platen.

If necessary remove the water spray platen to clean it separately as per step 3 of paragraph B.

9. Turn again the program selector on **CLEANING/RINSING**. The water pump is again in operation to circulate the water in order to rinse the entire water system.
10. Flush out the rinsing water from the sump reservoir then turn the program selector on **RESET/HI TEMPERATURE** position and immediately afterwards to **FREEZING OPERATION**.

NOTE By setting the selector on **RE-SET** first and then to **FREEZING OPERATION** the ice maker will perform the 5 minutes WATER FILLING phase i.e. the water inlet solenoid valve opens to allow the incoming water to rinse again the water system and to properly fill-up the sump reservoir for the next freezing cycle.

11. Replace the evaporator cover and the unit service panels.
12. At completion of the freezing and harvest cycle make sure of proper texture and clearness of the ice cubes and that, they do not have any acid taste.

ATTENTION In case the Ice cubes are cloudy-white and have an acid taste, melt them immediately by pouring on some warm water in order to prevent somebody using them.

13. Wipe clean and rinse the inner surfaces of the storage bin.

REMEMBER To prevent the accumulation of undesirable bacteria it is **necessary to sanitise the interior of the storage bin** with an anti-algae disinfectant solution **every week**.