

**PRO A CABINET
&
COUNTER
WITH
LF28
TEMPERATURE
CONTROLLER**

Service Manual



ISO 14001



ISO 9001



In Accordance with
the Royal Warrant of 1986
to the Queen's Printer
and the Royal Warrant of 1987
to the Controller of Her Majesty's Stationery Office



Contents

| | |
|---------------------------------------|----------|
| Environmental Management Policy | 1 |
| Disposal Requirements | 1 |
| Cabinet description | 2 |
| Controller Operation | 2 to 4 |
| Information Menu | 4 |
| Parameter Setting and Adjustment | 4 |
| Fuzzy Logic | 4 to 5 |
| Controller Electrical Connections | 5 |
| Probe Resistance Values | 5 |
| Parameters Cabinets & Counters | 6 to 11 |
| Parameters Bakery Cabinets & Counters | 12 to 14 |
| Technical Specification | 15 |
| Wiring Diagrams | 16 to 17 |

Environmental Management Policy for Service Manuals and Duets.

Product Support and Installation Contractors

Foster Refrigerator recognises that its activities, products and services can have an adverse impact upon the environment.

The organisation is committed to implementing systems and controls to manage, reduce and eliminate its adverse environmental impacts wherever possible, and has formulated an Environmental Policy outlining our core aims. A copy of the Environmental Policy is available to all contractors and suppliers upon request.

The organisation is committed to working with suppliers and contractors where their activities have the potential to impact upon the environment. To achieve the aims stated in the Environmental Policy we require that all suppliers and contractors operate in compliance with the law and are committed to best practice in environmental management.

Product Support and Installation contractors are required to:

1. Ensure that wherever possible waste is removed from the client's site, where arrangements are in place all waste should be returned to Foster Refrigerator's premises. In certain circumstances waste may be disposed of on the clients site; if permission is given, if the client has arrangements in place for the type of waste.
2. If arranging for the disposal of your waste, handle, store and dispose of it in such a way as to prevent its escape into the environment, harm to human health, and to ensure the compliance with the environmental law. Guidance is available from the Environment Agency on how to comply with the waste management 'duty of care'.
3. The following waste must be stored of separately from other wastes, as they are hazardous to the environment: refrigerants, polyurethane foam, oils.
4. When arranging for disposal of waste, ensure a waste transfer note or consignment note is completed as appropriate. Ensure that all waste is correctly described on the waste note and include the appropriate six-digit code from the European Waste Catalogue. Your waste contractor or Foster can provide further information if necessary.
5. Ensure that all waste is removed by a registered waste carrier, a carrier in possession of a waste management licence, or a carrier holding an appropriate exemption. Ensure the person receiving the waste at its ultimate destination is in receipt of a waste management licence or valid exemption.
6. Handle and store refrigerants in such a way as to prevent their emission to atmosphere, and ensure they are disposed of safely and in accordance with environmental law.
7. Make arrangements to ensure all staff who handle refrigerants do so at a level of competence consistent with the City Guilds 2078 Handling Refrigerants qualification or equivalent qualification.
8. Ensure all liquid substances are securely stored to prevent leaks and spill, and are **not** disposed of to storm drains, foul drain, surface water to soil.

DISPOSAL REQUIREMENTS

If not disposed of properly all refrigerators have components that can be harmful to the environment. All old refrigerators must be disposed of by appropriately registered and licensed waste contractors, and in accordance with national laws and regulations.

Cabinet Description

Pro cabinets.

The Pro range consists of a choice of capacities and temperature ranges in the full gastronorm format (650 x 530 shelf) and the non gastronorm (530x 550 shelf) formats.
The cabinets are manufactured as a one piece foam shell with easy clean stainless steel exterior
The cabinets conform to current legislation and exceed the Montreal protocol using zero ODP refrigerants and insulation with Hydrocarbon refrigerant as an option.
There are 3 temperature options exceeding Climate Class 5 operation up to 43°C ambient.
Temperature is controlled by a LAE microprocessor control with digital temperature display.
The standard refrigeration system is integral with an air-cooled condensing unit with the refrigerant distribution into the evaporator controlled by capillary.
Remote systems are available as an option with the refrigerant distribution into the evaporator controlled by expansion valve.
The cooled air is circulated through the evaporator, via the fan into the storage area.
Easy removable plug box and lid.
Coated coils prevent corrosion and prolong refrigeration life.
Removable thermal break giving easy access to the door frame heater.
Easy to read temperature display with wipe clean finish.
Wide magnetic gasket giving a positive door seal.

Pro counters.

The Pro range consists of a choice of capacities and temperature ranges in the full gastronorm format (650 x 530 shelf) and the non gastronorm (530x 550 shelf) formats.
The cabinets are manufactured as a one piece foam shell with easy clean stainless steel exterior
The cabinets conform to current legislation and exceed the Montreal protocol using zero ODP refrigerants and insulation with Hydrocarbon refrigerant as an option.
There are 3 temperature options exceeding Climate Class 5 operation up to 43°C ambient.
Temperature is controlled by a LAE microprocessor control with digital temperature display.
The standard refrigeration system is integral with an air-cooled condensing unit with the refrigerant distribution into the evaporator controlled by capillary.
Remote systems are available as an option with the refrigerant distribution into the evaporator controlled by expansion valve.
The cooled air is circulated through the evaporator, via the fan into the storage area.
Easy accessible condensing unit fitted on slides for ease of servicing.
Coated coils prevent corrosion and prolong refrigeration life.
Removable thermal break giving easy access to the door frame heater.
Easy to read temperature display with wipe clean finish.
Wide magnetic gasket giving a positive door seal.

Controller Operation

LF 28B2SE-B (00-555920) Controller



LCD 16 Display (00-555740)

Operation Guidelines

Initial Start Up.

Start Up & self Test:

The indication is only displayed during the first three seconds following the mains electrical power being applied to the unit. During this period the controller performs a self-check.

Once the self-check has been completed **OFF** will be displayed.

Press and hold  for three seconds. The unit will start and the air temperature will be displayed.

Check temperature set point.

Important to note that the ability to increase and decrease the set point is not a function available to the user as the set point is fixed. To make adjustments to the set point it is necessary to access the parameter and alter SPL and SPH accordingly.

Check set point by pressing the button 

To increase set point press  +  until required temperature is displayed.

To decrease set point press  +  until required temperature is displayed.

Factory Temperature Set Point



Refrigerator +1°C to +4°C

Meat 0°C to 2°C.

Freezer -18°C to -21°C.

Exit from set up occurs after 10 seconds if no button is pressed.

Manual Defrost.

To initiate a manual defrost press  and  hold will be displayed release. 

On completion of the defrost  will be displayed until the cabinet temperature is achieved and then it will revert to displaying the normal cabinet temperature.

Set Unit to Standby.

Press  display shows 

This indication is displayed while the unit is not operating but with mains power applied to the unit. This mode may be used for internal cleaning regimes and short periods when the unit is not required.

For extended periods of inactivity the mains supply should be isolated.

Alarm and Warnings

High temperature alarm

 Will be displayed.

The alarm will sound but can be silenced by pressing any of the buttons, however it will return after the pre-set designated period. The unit returning to normal operating temperature will automatically cancel the alarm.

Possible Causes: Evaporator fan not working. Restricted airflow through airduct. Evaporator iced up. Compressor not working.

Low temperature alarm.

 Will be displayed.

The alarm will sound but can be silenced by pressing any of the buttons and the unit will continue to operate, however it will return after the pre-set designated period. The unit returning to normal operating temperature will automatically cancel the alarm.

Possible Causes: Controller faulty (not switching compressor off). Compressor secondary relay will not de-energise (low temperature models).

Door Open Alarm. (Only applies to cabinets fitted with door switches.)

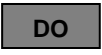
 Will be displayed.

The alarm will sound but can be silenced by pressing. 

The display will continue to display the alarm message until cancelled by shutting the door.

If the alarm cannot be cancelled by doing this call your Foster Authorised Service Company.

Possible Causes: Faulty door switch. Door left open for more than 5minutes.

High Pressure Alarm (Only applies to machines fitted with a condenser probe).

 Will be displayed

This alarm relate to the condenser which must be checked and cleaned at regular intervals the frequency being determined by site conditions.

The alarm will sound but can be silenced by pressing any of the buttons and the unit will continue to operate, however it will return after the pre-set designated period. The unit returning to normal operating temperature will automatically cancel the alarm.

Possible Causes: Condenser fan not working. Condenser blocked/ dirty. Condenser obstructed.

Air Temperature Probe Failure.

E1

Will be displayed.

The alarm will sound but can be silenced by pressing any button.

There is no further action that can be taken by the user in this instance. During this period the unit will continue to operate but have a reduced performance.

Action: Replace Probe.

Evaporator Temperature Probe Failure. (Automatic Defrost Cabinets Only)

E2

Will be displayed.

The alarm will sound but can be silenced by pressing any button.



There is no further action that can be taken by the user in this instance. During this period the unit will continue to operate satisfactorily, but this failure will have an effect on the defrost and therefore efficiency if allowed to continue.

Action: Replace Probe.

Information Menu

Pressing and releasing  activates the information menu. From this menu you can display the temperature relating to T1 (air probe), T2 (evaporator probe, if fitted) and T3 (condenser probe, if fitted). The maximum temperature (THI) and the minimum temperature (TLO) the cabinet has achieved since it was last re-set.

The total operating time of the condenser (CND), since it was last cleaned, and the keyboard status (LOC).

The information to be displayed can be selected sequentially by pressing  repeatedly or scrolling through the menu using the  or  buttons.

Once selected press  to display the value

Exit from the info menu by pressing  or is automatic after 6 seconds if no buttons are pressed.

To reset the temperature settings recorded in THI and TLO and the hours counted in CND, access the info menu press  to display the value plus  simultaneously for resetting to be completed.



To check the LOC status scroll through to LOC, press to display status – YES to lock keys. – NO to leave keys accessible.

NOTE: with the keys locked it is not possible to turn the unit off or ON or to check the set point







Parameter Setting and Adjustment

It is strongly advised that before adjusting any Service Parameters a thorough understanding of the following instructions should be obtained.

The parameters are accessed by pressing the following keys in succession  +  and keeping them pressed for 5 seconds.

After this period the first parameter 'SCL' will be displayed.

Press button  to pass from one parameter to the next and button  to go back.

Press  to display the value +  or  to change it.

Exit from set up is by pressing  or is automatic if no buttons are pressed for 30 seconds

Fuzzy Logic.

These are settings that maintain the temperature of the cabinet in a more energy efficient manner. It works by controlling the evaporator fan/s, defrost and temperature in low usage times by transferring the operation to a second set of economy parameters.

When the cabinet is first switched On the economy settings control the operation of the temperature and will remain at those settings until the controller, by monitoring the door opening frequency and the air and evaporator temperatures, identifies a higher usage and switches over to the 11SM (2nd parameter set management).

When the economy settings are activated the cabinet temperature is allowed to rise to the setting (SP) setpoint [1]. This is set to a higher temperature setting to allow the air temperature to rise without having much of an impact on the product temperature.

In addition the fan/s will modulate (cycle for 30 seconds) as set in (FPC) evaporator fan On / Off Ratio. The parameter is set at 1.

Changing the setting to 0 will have the fan running with the compressor. Set to 1 the fan will run for 30 seconds on and 60 seconds off. Set to 2 the fan will run for 60 seconds on and 60 seconds off and set to 3 the fan will run for 90 seconds on and 60 seconds off.

With FPC set to 1, 2 or 3 the fans will generate less heat into the cabinet therefore reduce the requirement of the condensing system.

NOTE:

Parameter FPC will only function with the parameter FTC set for YES. With FTC set to NO the fan will run all of the time apart from during defrost when it will be off during electric and hot gas defrost but on during a timed off cycle defrost.

Fan Operation.

The evaporator fan/s will run normally when the compressor is running but will commence cycling when the compressor is in the off cycle mode.

The fans will run without the compressor during timed off cycle defrost but will not run during hot gas or electric defrost.

For models that don't have door switches fitted the fuzzy logic will not function as the controller is unable to monitor door opening factors.

Auto Defrost operation.

The defrost frequency is determined by the usage of the machine.

In the economy mode it may not perform a defrost as by monitoring the air temperature, evaporator temperature and door opening factor it may decide that there is insufficient ice build up on the evaporator so defrosting is not required.

The parameter DFR (defrost frequency) is set for 3. The cabinet will perform at least 1 defrost per day and with the setting at 3 it has the potential to initiate up to 2 additional defrost in the economy mode.

Should the cabinet experience constant usage the controller will switch automatically to the second parameter settings indicated by the controller LED adjacent to **II** illuminating, which could under circumstances of heavy usage initiate up to 6 defrosts per day.

The second parameter settings preceded by 11 will now be active,

It is important to note that during the first few days of operation the defrosting frequency may be at regular intervals but these will reduce as the controller monitors the operation.

Controller Electrical Connections

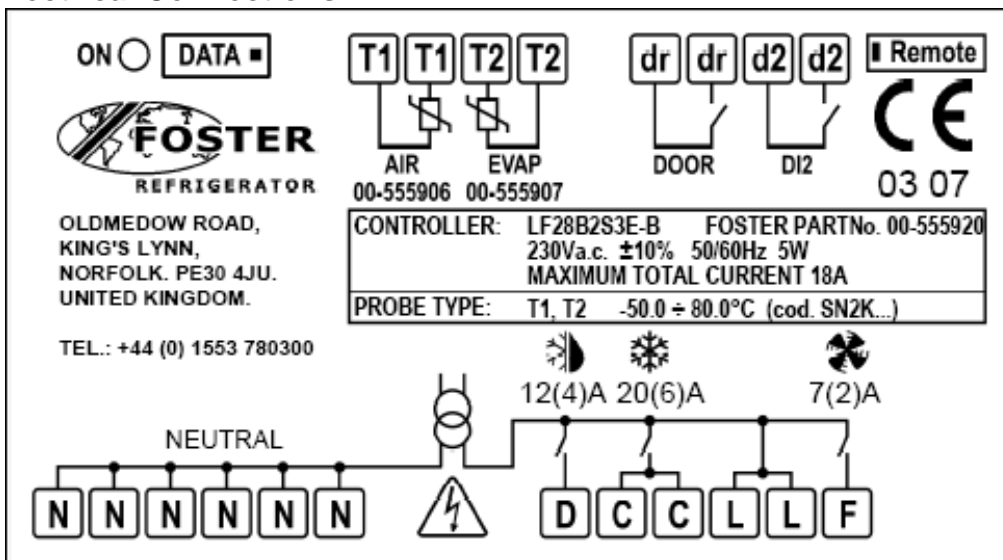

Probes

Air and Evaporator Probes

The air and evaporator probes are the same and are identified as T1 Air Probe and T2 Evaporator Probe. These are the K2 NTC thermistor type and are fully enclosed to make it completely waterproof and resilient to temperature variation within the limits of rapid cycling. The probe is capable of measuring temperature in excess of -30°C and 50°C with 1°K accuracy at 1°C and no more than 2°K at the upper and lower temperature ranges.

Probe temperature resistance values

| °C | K ohm | °C | K ohm | °C | K ohm | °C | K ohm | °C | K ohm |
|-----|--------|-----|--------|----|-------|----|-------|----|-------|
| -25 | 19.402 | -15 | 11.644 | 5 | 4.571 | 15 | 2.987 | 25 | 2 |
| -20 | 14.961 | -10 | 8.133 | 10 | 3.682 | 20 | 2.437 | 40 | 1.143 |

F 28B2SE-B (00-555920) Controller Parameter lists

Parameter list for High Temperature cabinets including: -

PROB600H-A, PROG1100H-A, PROG1350H, PROG1350HP-A, PROG 300/300HH-A, PROG500H-A, PROG600H-A, PROG600HP-A, PROG600HE-A, PROS400H-A, PSG1100H-A, PSG1350H-A, PSG300/300H-A, PSG500H-A, PSG600H-A, PSG600HE-A, PSS1000H-A, PSS450H-A. Also remote condensing unit models (R).

Parameter list for High Temperature counters including: -

LL1/2H-A, PRO1/2H-A, PRO1/2HR-A, PRO1/3H-A, PRO1/3HR-A, PRO1/4H-A, PRO1/4HR-A, PRO2/1H-A, PRO2/1HR-A, PRO2/2H-A, PRO2/2HR-A, PRO2/3H-A, PRO2/3HR-A, Also remote condensing unit models (R).

Note: For all counters adjust parameter 'DS' to NO as door switches are not fitted to these models.

| Mnem. | Definition | Min. | Max | Default | Dim. | HT |
|-------|---|------------------------------|------|---------|-------|-----|
| SCL | Readout scale | 1°C; 2°C; °F | | 2 | flag | 2 |
| SPL | Minimum setpoint [I] | -40 | SPH | 1 | °C | 1 |
| SPH | Maximum setpoint [I] | SPL | 40 | 3 | °C | 3 |
| SP | Setpoint [I] | SPL | SPH | 2 | °C | 2 |
| HYS | Thermostat hysteresis [I] | 0.1 | 10 | 3 | °K | 3 |
| CRT | Minimum compressor rest time | 0 | 30 | 2 | min. | 2 |
| CT1 | Compressor run with T1 failure | 0 | 30 | 7 | min. | 7 |
| CT2 | Compressor stop with T1 failure | 0 | 30 | 3 | min. | 3 |
| 2CD | Start delay 2nd compressor | 0 | 120 | 0 | sec. | 0 |
| DFR | Defrost frequency / 24h | 0 | 24 | 2 | 1/24h | 2 |
| DLI | Defrost end temperature | -40 | 40 | 20 | °C | 20 |
| DTO | Maximum defrost duration | 1 | 120 | 20 | min. | 20 |
| DTY | Defrost type | OFF; ELE; GAS | | OFF | flag | OFF |
| DRN | Drain down time | 0 | 30 | 2 | min. | 2 |
| DDY | Defrost display control | 0 | 60 | 10 | min. | 10 |
| FID | Fan activity during defrost | NO | YES | YES | flag | YES |
| FDD | Fan re-start delay temperature | -40 | 40 | 0 | °C | 0 |
| FTO | Evaporator fan maximum time-out | 0 | 120 | 3 | min. | 3 |
| FTC | Evaporator fan timed control | NO | YES | YES | flag | YES |
| FT1 | Fan stop delay | 0 | 180 | 15 | sec. | 15 |
| FT2 | Timed fan stop | 0 | 30 | 2 | min. | 2 |
| FT3 | Timed fan run | 0 | 30 | 1 | min. | 1 |
| ATL | Low alarm differential | -12 | 0 | -5 | °K | -5 |
| ATH | High alarm differential | 0 | 12 | 5 | °K | 5 |
| ATD | Alarm Temperature Delay | 0 | 120 | 90 | min. | 90 |
| AHT | Condenser Alarm Temperature | 0 | 75 | 60 | °C | 60 |
| AHM | Condenser high temp. alarm operation | NON; ALR; STP | | NON | flag | NON |
| ACC | Condenser cleaning period | 0 | 52 | 0 | wks | 0 |
| HDS | Sensitivity function eco / heavy duty | 1 | 5 | 3 | flag | 3 |
| IISM | 2nd parameter set switching mode | NON; MAN; HDD; DI2 | | HDD | flag | HDD |
| IISL | Minimum 2nd temp. set | -40 | IISH | 1 | °C | 1 |
| IISH | Maximum 2nd temp. set | IISL | 40 | 3 | °C | 3 |
| IISP | Effective 2nd temperature set point | IISL | IISH | 1 | °C | 1 |
| IIHY | Hysteresis 2nd temperature set | 0.1 | 10 | 3 | °K | 3 |
| IIFT | Evap. fan timed control in mode 2 | NO | YES | NO | flag | NO |
| IIDF | Defrost Frequency / 24h in mode 2 | 0 | 24 | 4 | 1/24h | 4 |
| SB | Button 0/1 enabling | NO | YES | YES | flag | YES |
| DS | Door switch enabling | NO | YES | YES | flag | YES |
| CSD | Compressor stop delay from door opening | 0 | 30 | 1 | min. | 1 |
| ADO | Door alarm delay | 0 | 30 | 8 | min. | 8 |
| D12 | Function digital input D12 | NON; HPS; IISM; RDS | | NON | flag | NON |
| LSM | Light switch mode | NON; MAN; DOR | | NON | flag | NON |
| OAU | Control of AUX output | NON; 0-1; LGT; 2CU; 2EU; ALR | | NON | flag | NON |
| OS1 | T1 (air) probe offset | -12 | 12 | 0 | °K | 0 |
| T2 | T2 (evap.) probe enabling | NO | YES | NO | flag | NO |
| OS2 | T2 (evap.) probe offset | -12 | 12 | 0 | °K | 0 |
| T3 | T3 (cond.) probe enabling | NO | YES | NO | flag | NO |
| OS3 | T3 (cond.) probe offset | -12 | 12 | 0 | °K | 0 |
| T4 | T4 (aux.) probe enabling | NON; 2CU; 2EU | | NON | flag | NON |
| OS4 | T4 (aux.) probe offset | -12 | 12 | 0 | °K | 0 |
| TLD | Delay for min./max. temp storage | 1 | 30 | 5 | min. | 5 |
| SIM | Display slowdown | 0 | 100 | 3 | exp. | 3 |
| ADR | Unit peripheral address | 1 | 255 | 1 | exp. | 1 |

Parameter list for Low Temperature cabinets with hot gas defrost including: -

PROB600L-A, PROG1100L-A, PROG1350L-A, PROG300/300L-A, PROG500L-A, PROG600L-A, PROG600LE-A, PROS400L-A, PSG1100L-A, PSG1350L-A, PSG300/300L-A, PSG500L-A, PSG600L-A, PSG600LE-A, PSS1000L-A

Parameter list for Low Temperature counters with hot gas defrost including: -

PRO1/2L-A, PRO1/3L-A, PRO1/4L-A, PRO2/1L-A, PRO2/2L-A, PRO2/3L-A,

Note: For all counters adjust parameter 'DS' to NO as door switches are not fitted to these models.

| Mnem. | Definition | Min. | Max | Default | Dim. | LT Gas |
|-------|---|------------------------------|------|---------|-------|--------|
| SCL | Readout scale | 1°C; 2°C; °F | | 2 | flag | 2 |
| SPL | Minimum setpoint [I] | -40 | SPH | 1 | °C | -21 |
| SPH | Maximum setpoint [I] | SPL | 40 | 3 | °C | -19 |
| SP | Setpoint [I] | SPL | SPH | 2 | °C | -19 |
| HYS | Thermostat hysteresis [I] | 0.1 | 10 | 3 | °K | 3 |
| CRT | Minimum compressor rest time | 0 | 30 | 2 | min. | 2 |
| CT1 | Compressor run with T1 failure | 0 | 30 | 7 | min. | 7 |
| CT2 | Compressor stop with T1 failure | 0 | 30 | 3 | min. | 3 |
| 2CD | Start delay 2nd compressor | 0 | 120 | 0 | sec. | 0 |
| DFR | Defrost frequency / 24h | 0 | 24 | 2 | 1/24h | 4 |
| DLI | Defrost end temperature | -40 | 40 | 20 | °C | 20 |
| DTO | Maximum defrost duration | 1 | 120 | 20 | min. | 20 |
| DTY | Defrost type | OFF; ELE; GAS | | OFF | flag | GAS |
| DRN | Drain down time | 0 | 30 | 2 | min. | 2 |
| DDY | Defrost display control | 0 | 60 | 10 | min. | 10 |
| FID | Fan activity during defrost | NO | YES | YES | flag | NO |
| FDD | Fan re-start delay temperature | -40 | 40 | 0 | °C | 0 |
| FTO | Evaporator fan maximum time-out | 0 | 120 | 3 | min. | 3 |
| FTC | Evaporator fan timed control | NO | YES | YES | flag | YES |
| FT1 | Fan stop delay | 0 | 180 | 15 | sec. | 15 |
| FT2 | Timed fan stop | 0 | 30 | 2 | min. | 3 |
| FT3 | Timed fan run | 0 | 30 | 1 | min. | 1 |
| ATL | Low alarm differential | -12 | 0 | -5 | °K | -5 |
| ATH | High alarm differential | 0 | 12 | 5 | °K | 5 |
| ATD | Alarm Temperature Delay | 0 | 120 | 90 | min. | 90 |
| AHT | Condenser Alarm Temperature | 0 | 75 | 60 | °C | 60 |
| AHM | Condenser high temp. alarm operation | NON; ALR; STP | | NON | flag | NON |
| ACC | Condenser cleaning period | 0 | 52 | 0 | wks | 0 |
| HDS | Sensitivity function eco / heavy duty | 1 | 5 | 3 | flag | 3 |
| IISM | 2nd parameter set switching mode | NON; MAN; HDD; DI2 | | HDD | flag | HDD |
| IISL | Minimum 2nd temp. set | -40 | IISH | 1 | °C | -21 |
| IISH | Maximum 2nd temp. set | IISL | 40 | 3 | °C | -21 |
| IISP | Effective 2nd temperature set point | IISL | IISH | 1 | °C | -21 |
| IIHY | Hysteresis 2nd temperature set | 0.1 | 10 | 3 | °K | 3 |
| IIFT | Evap. fan timed control in mode 2 | NO | YES | NO | flag | NO |
| IIDF | Defrost Frequency / 24h in mode 2 | 0 | 24 | 4 | 1/24h | 4 |
| SB | Button 0/1 enabling | NO | YES | YES | flag | YES |
| DS | Door switch enabling | NO | YES | YES | flag | YES |
| CSD | Compressor stop delay from door opening | 0 | 30 | 1 | min. | 1 |
| ADO | Door alarm delay | 0 | 30 | 8 | min. | 8 |
| D12 | Function digital input D12 | NON; HPS; IISM; RDS | | NON | flag | NON |
| LSM | Light switch mode | NON; MAN; DOR | | NON | flag | NON |
| OAU | Control of AUX output | NON; 0-1; LGT; 2CU; 2EU; ALR | | NON | flag | NON |
| OS1 | T1 (air) probe offset | -12 | 12 | 0 | °K | 0 |
| T2 | T2 (evap.) probe enabling | NO | YES | NO | flag | YES |
| OS2 | T2 (evap.) probe offset | -12 | 12 | 0 | °K | 0 |
| T3 | T3 (cond.) probe enabling | NO | YES | NO | flag | NO |
| OS3 | T3 (cond.) probe offset | -12 | 12 | 0 | °K | 0 |
| T4 | T4 (aux.) probe enabling | NON; 2CU; 2EU | | NON | flag | NON |
| OS4 | T4 (aux.) probe offset | -12 | 12 | 0 | °K | 0 |
| TLD | Delay for min./max. temp storage | 1 | 30 | 5 | min. | 5 |
| SIM | Display slowdown | 0 | 100 | 3 | exp. | 3 |
| ADR | Unit peripheral address | 1 | 255 | 1 | exp. | 1 |

Parameter list for Low Temperature cabinets with electric defrost including: -
PROB600LR-A, PROG500LR-A, PROG600LR-A, PROS400LR-A, PSG500LR-A, PSG600LR-A, PSS1000L-A,
PSS450L-A, PRO S 400L-A, PRO G600LU-A,
PROB600LW-A & PFB600LW for these models adjust parameter 'DTO' to 10.

Parameter list for Low Temperature counters with electric defrost including: -
PRO1/2LR-A, PRO1/3LR-A, PRO1/4LR-A, PRO2/1LR, PRO2/2LR-A, PRO2/3LR-A,

Note: For all counters adjust parameter 'DS' to NO as door switches are not fitted to these models.

| Mnem. | Definition | Min. | Max | Default | Dim. | LT Electric |
|-------|---|------------------------------|------|---------|-------|-------------|
| SCL | Readout scale | 1°C; 2°C; °F | | 2 | flag | 2 |
| SPL | Minimum setpoint [I] | -40 | SPH | 1 | °C | -21 |
| SPH | Maximum setpoint [I] | SPL | 40 | 3 | °C | -19 |
| SP | Setpoint [I] | SPL | SPH | 2 | °C | -19 |
| HYS | Thermostat hysteresis [I] | 0.1 | 10 | 3 | °K | 3 |
| CRT | Minimum compressor rest time | 0 | 30 | 2 | min. | 2 |
| CT1 | Compressor run with T1 failure | 0 | 30 | 7 | min. | 7 |
| CT2 | Compressor stop with T1 failure | 0 | 30 | 3 | min. | 3 |
| 2CD | Start delay 2nd compressor | 0 | 120 | 0 | sec. | 0 |
| DFR | Defrost frequency / 24h | 0 | 24 | 2 | 1/24h | 4 |
| DLI | Defrost end temperature | -40 | 40 | 20 | °C | 20 |
| DTO | Maximum defrost duration | 1 | 120 | 20 | min. | 20 |
| DTY | Defrost type | OFF; ELE; GAS | | OFF | flag | ELE |
| DRN | Drain down time | 0 | 30 | 2 | min. | 2 |
| DDY | Defrost display control | 0 | 60 | 10 | min. | 10 |
| FID | Fan activity during defrost | NO | YES | YES | flag | NO |
| FDD | Fan re-start delay temperature | -40 | 40 | 0 | °C | 0 |
| FTO | Evaporator fan maximum time-out | 0 | 120 | 3 | min. | 3 |
| FTC | Evaporator fan timed control | NO | YES | YES | flag | YES |
| FT1 | Fan stop delay | 0 | 180 | 15 | sec. | 15 |
| FT2 | Timed fan stop | 0 | 30 | 2 | min. | 3 |
| FT3 | Timed fan run | 0 | 30 | 1 | min. | 1 |
| ATL | Low alarm differential | -12 | 0 | -5 | °K | -5 |
| ATH | High alarm differential | 0 | 12 | 5 | °K | 5 |
| ATD | Alarm Temperature Delay | 0 | 120 | 90 | min. | 90 |
| AHT | Condenser Alarm Temperature | 0 | 75 | 60 | °C | 60 |
| AHM | Condenser high temp. alarm operation | NON; ALR; STP | | NON | flag | NON |
| ACC | Condenser cleaning period | 0 | 52 | 0 | wks | 0 |
| HDS | Sensitivity function eco / heavy duty | 1 | 5 | 3 | flag | 3 |
| IISM | 2nd parameter set switching mode | NON; MAN; HDD; DI2 | | HDD | flag | HDD |
| IISL | Minimum 2nd temp. set | -40 | IISH | 1 | °C | -21 |
| IISH | Maximum 2nd temp. set | IISL | 40 | 3 | °C | -21 |
| IISP | Effective 2nd temperature set point | IISL | IISH | 1 | °C | -21 |
| IIHY | Hysteresis 2nd temperature set | 0.1 | 10 | 3 | °K | 3 |
| IIFT | Evap. fan timed control in mode 2 | NO | YES | NO | flag | NO |
| IIDF | Defrost Frequency / 24h in mode 2 | 0 | 24 | 4 | 1/24h | 4 |
| SB | Button 0/1 enabling | NO | YES | YES | flag | YES |
| DS | Door switch enabling | NO | YES | YES | flag | YES |
| CSD | Compressor stop delay from door opening | 0 | 30 | 1 | min. | 1 |
| ADO | Door alarm delay | 0 | 30 | 8 | min. | 8 |
| D12 | Function digital input D12 | NON; HPS; IISM; RDS | | NON | flag | NON |
| LSM | Light switch mode | NON; MAN; DOR | | NON | flag | NON |
| OAU | Control of AUX output | NON; 0-1; LGT; 2CU; 2EU; ALR | | NON | flag | NON |
| OS1 | T1 (air) probe offset | -12 | 12 | 0 | °K | 0 |
| T2 | T2 (evap.) probe enabling | NO | YES | NO | flag | YES |
| OS2 | T2 (evap.) probe offset | -12 | 12 | 0 | °K | 0 |
| T3 | T3 (cond.) probe enabling | NO | YES | NO | flag | NO |
| OS3 | T3 (cond.) probe offset | -12 | 12 | 0 | °K | 0 |
| T4 | T4 (aux.) probe enabling | NON; 2CU; 2EU | | NON | flag | NON |
| OS4 | T4 (aux.) probe offset | -12 | 12 | 0 | °K | 0 |
| TLD | Delay for min./max. temp storage | 1 | 30 | 5 | min. | 5 |
| SIM | Display slowdown | 0 | 100 | 3 | exp. | 3 |
| ADR | Unit peripheral address | 1 | 255 | 1 | exp. | 1 |

Parameter list for Meat Temperature cabinets with hot gas defrost including: -

PROB600M-A, PROG1350M-A, PROG600M-A, PSG1350M-A, PSG600M-A, PROS525M-A, PROS950M-A, PROG1100M-A, PROS1500M-A, PROS400M-A, PSG1100M-A, PSG500M-A.

Parameter list for Meat Temperature counters with hot gas defrost including: -

LL2/1MD-A, LL2/1MS-A, LL2/2M-A, LL2/4M-A, PRO1/2M-A, PRO1/3M-A, PRO1/4M-A, PRO2/1M-A, PRO2/2M-A, PRO2/3M-A.

Note: For all counters adjust parameter 'DS' to NO as door switches are not fitted to these models.

| Mnem. | Definition | Min. | Max | Default | Dim. | MT Gas |
|-------|---|------------------------------|------|---------|-------|--------|
| SCL | Readout scale | 1°C; 2°C; °F | | 2 | flag | 2 |
| SPL | Minimum setpoint [I] | -40 | SPH | 1 | °C | -2 |
| SPH | Maximum setpoint [I] | SPL | 40 | 3 | °C | 0 |
| SP | Setpoint [I] | SPL | SPH | 2 | °C | -1 |
| HYS | Thermostat hysteresis [I] | 0.1 | 10 | 3 | °K | 2 |
| CRT | Minimum compressor rest time | 0 | 30 | 2 | min. | 2 |
| CT1 | Compressor run with T1 failure | 0 | 30 | 7 | min. | 7 |
| CT2 | Compressor stop with T1 failure | 0 | 30 | 3 | min. | 3 |
| 2CD | Start delay 2nd compressor | 0 | 120 | 0 | sec. | 0 |
| DFR | Defrost frequency / 24h | 0 | 24 | 2 | 1/24h | 4 |
| DLI | Defrost end temperature | -40 | 40 | 20 | °C | 20 |
| DTO | Maximum defrost duration | 1 | 120 | 20 | min. | 20 |
| DTY | Defrost type | OFF; ELE; GAS | | OFF | flag | GAS |
| DRN | Drain down time | 0 | 30 | 2 | min. | 2 |
| DDY | Defrost display control | 0 | 60 | 10 | min. | 10 |
| FID | Fan activity during defrost | NO | YES | YES | flag | NO |
| FDD | Fan re-start delay temperature | -40 | 40 | 0 | °C | 0 |
| FTO | Evaporator fan maximum time-out | 0 | 120 | 3 | min. | 3 |
| FTC | Evaporator fan timed control | NO | YES | YES | flag | YES |
| FT1 | Fan stop delay | 0 | 180 | 15 | sec. | 15 |
| FT2 | Timed fan stop | 0 | 30 | 2 | min. | 3 |
| FT3 | Timed fan run | 0 | 30 | 1 | min. | 1 |
| ATL | Low alarm differential | -12 | 0 | -5 | °K | -5 |
| ATH | High alarm differential | 0 | 12 | 5 | °K | 5 |
| ATD | Alarm Temperature Delay | 0 | 120 | 90 | min. | 90 |
| AHT | Condenser Alarm Temperature | 0 | 75 | 60 | °C | 60 |
| AHM | Condenser high temp. alarm operation | NON; ALR; STP | | NON | flag | NON |
| ACC | Condenser cleaning period | 0 | 52 | 0 | wks | 0 |
| HDS | Sensitivity function eco / heavy duty | 1 | 5 | 3 | flag | 3 |
| IISM | 2nd parameter set switching mode | NON; MAN; HDD; DI2 | | HDD | flag | HDD |
| IISL | Minimum 2nd temp. set | -40 | IISH | 1 | °C | -2 |
| IISH | Maximum 2nd temp. set | IISL | 40 | 3 | °C | 0 |
| IISP | Effective 2nd temperature set point | IISL | IISH | 1 | °C | -2 |
| IIHY | Hysteresis 2nd temperature set | 0.1 | 10 | 3 | °K | 2 |
| IIFT | Evap. fan timed control in mode 2 | NO | YES | NO | flag | NO |
| IIDF | Defrost Frequency / 24h in mode 2 | 0 | 24 | 4 | 1/24h | 4 |
| SB | Button 0/1 enabling | NO | YES | YES | flag | YES |
| DS | Door switch enabling | NO | YES | YES | flag | YES |
| CSD | Compressor stop delay from door opening | 0 | 30 | 1 | min. | 1 |
| ADO | Door alarm delay | 0 | 30 | 8 | min. | 8 |
| D12 | Function digital input D12 | NON; HPS; IISM; RDS | | NON | flag | NON |
| LSM | Light switch mode | NON; MAN; DOR | | NON | flag | NON |
| OAU | Control of AUX output | NON; 0-1; LGT; 2CU; 2EU; ALR | | NON | flag | NON |
| OS1 | T1 (air) probe offset | -12 | 12 | 0 | °K | 0 |
| T2 | T2 (evap.) probe enabling | NO | YES | NO | flag | YES |
| OS2 | T2 (evap.) probe offset | -12 | 12 | 0 | °K | 0 |
| T3 | T3 (cond.) probe enabling | NO | YES | NO | flag | NO |
| OS3 | T3 (cond.) probe offset | -12 | 12 | 0 | °K | 0 |
| T4 | T4 (aux.) probe enabling | NON; 2CU; 2EU | | NON | flag | NON |
| OS4 | T4 (aux.) probe offset | -12 | 12 | 0 | °K | 0 |
| TLD | Delay for min./max. temp storage | 1 | 30 | 5 | min. | 5 |
| SIM | Display slowdown | 0 | 100 | 3 | exp. | 3 |
| ADR | Unit peripheral address | 1 | 255 | 1 | exp. | 1 |

Parameter list for Meat Temperature cabinets with electric defrost including: -

PROB600MW-A, PROG1350MR-A, PROG600MR-A, PSG1350MR-A, PSG600MR-A, CS1350MR-A, CS600MR-A, PROB600MR-A, PROG600MR-A, PROS525MR-A, PROS950MR-A, PROG1100MR-A, PROS11502MR-A, PROS400MR-A, PSG1100MR-A, PSG500MR-A, PSS1000M-A, PSS450M-A.

Parameter list for Meat Temperature counters with electric defrost including: -

PRO1/2MR-A, PRO1/3MR-A, PRO1/4MR-A, PRO2/1MR-A, PRO2/2MR-A, PRO2/3MR-A.

Note: For all counters adjust parameter 'DS' to NO as door switches are not fitted to these models.

| Mnem. | Definition | Min. | Max | Default | Dim. | MT Electric |
|-------|---|------------------------------|------|---------|-------|-------------|
| SCL | Readout scale | 1°C; 2°C; °F | | 2 | flag | 2 |
| SPL | Minimum setpoint [I] | -40 | SPH | 1 | °C | -2 |
| SPH | Maximum setpoint [I] | SPL | 40 | 3 | °C | 0 |
| SP | Setpoint [I] | SPL | SPH | 2 | °C | -1 |
| HYS | Thermostat hysteresis [I] | 0.1 | 10 | 3 | °K | 2 |
| CRT | Minimum compressor rest time | 0 | 30 | 2 | min. | 2 |
| CT1 | Compressor run with T1 failure | 0 | 30 | 7 | min. | 7 |
| CT2 | Compressor stop with T1 failure | 0 | 30 | 3 | min. | 3 |
| 2CD | Start delay 2nd compressor | 0 | 120 | 0 | sec. | 0 |
| DFR | Defrost frequency / 24h | 0 | 24 | 2 | 1/24h | 4 |
| DLI | Defrost end temperature | -40 | 40 | 20 | °C | 20 |
| DTO | Maximum defrost duration | 1 | 120 | 20 | min. | 20 |
| DTY | Defrost type | OFF; ELE; GAS | | OFF | flag | ELE |
| DRN | Drain down time | 0 | 30 | 2 | min. | 2 |
| DDY | Defrost display control | 0 | 60 | 10 | min. | 10 |
| FID | Fan activity during defrost | NO | YES | YES | flag | NO |
| FDD | Fan re-start delay temperature | -40 | 40 | 0 | °C | 0 |
| FTO | Evaporator fan maximum time-out | 0 | 120 | 3 | min. | 3 |
| FTC | Evaporator fan timed control | NO | YES | YES | flag | YES |
| FT1 | Fan stop delay | 0 | 180 | 15 | sec. | 15 |
| FT2 | Timed fan stop | 0 | 30 | 2 | min. | 3 |
| FT3 | Timed fan run | 0 | 30 | 1 | min. | 1 |
| ATL | Low alarm differential | -12 | 0 | -5 | °K | -5 |
| ATH | High alarm differential | 0 | 12 | 5 | °K | 5 |
| ATD | Alarm Temperature Delay | 0 | 120 | 90 | min. | 90 |
| AHT | Condenser Alarm Temperature | 0 | 75 | 60 | °C | 60 |
| AHM | Condenser high temp. alarm operation | NON; ALR; STP | | NON | flag | NON |
| ACC | Condenser cleaning period | 0 | 52 | 0 | wks | 0 |
| HDS | Sensitivity function eco / heavy duty | 1 | 5 | 3 | flag | 3 |
| IISM | 2nd parameter set switching mode | NON; MAN; HDD; DI2 | | HDD | flag | HDD |
| IISL | Minimum 2nd temp. set | -40 | IISH | 1 | °C | -2 |
| IISH | Maximum 2nd temp. set | IISL | 40 | 3 | °C | 0 |
| IISP | Effective 2nd temperature set point | IISL | IISH | 1 | °C | -2 |
| IIHY | Hysteresis 2nd temperature set | 0.1 | 10 | 3 | °K | 2 |
| IIFT | Evap. fan timed control in mode 2 | NO | YES | NO | flag | NO |
| IIDF | Defrost Frequency / 24h in mode 2 | 0 | 24 | 4 | 1/24h | 4 |
| SB | Button 0/1 enabling | NO | YES | YES | flag | YES |
| DS | Door switch enabling | NO | YES | YES | flag | YES |
| CSD | Compressor stop delay from door opening | 0 | 30 | 1 | min. | 1 |
| ADO | Door alarm delay | 0 | 30 | 8 | min. | 8 |
| D12 | Function digital input D12 | NON; HPS; IISM; RDS | | NON | flag | NON |
| LSM | Light switch mode | NON; MAN; DOR | | NON | flag | NON |
| OAU | Control of AUX output | NON; 0-1; LGT; 2CU; 2EU; ALR | | NON | flag | NON |
| OS1 | T1 (air) probe offset | -12 | 12 | 0 | °K | 0 |
| T2 | T2 (evap.) probe enabling | NO | YES | NO | flag | YES |
| OS2 | T2 (evap.) probe offset | -12 | 12 | 0 | °K | 0 |
| T3 | T3 (cond.) probe enabling | NO | YES | NO | flag | NO |
| OS3 | T3 (cond.) probe offset | -12 | 12 | 0 | °K | 0 |
| T4 | T4 (aux.) probe enabling | NON; 2CU; 2EU | | NON | flag | NON |
| OS4 | T4 (aux.) probe offset | -12 | 12 | 0 | °K | 0 |
| TLD | Delay for min./max. temp storage | 1 | 30 | 5 | min. | 5 |
| SIM | Display slowdown | 0 | 100 | 3 | exp. | 3 |
| ADR | Unit peripheral address | 1 | 255 | 1 | exp. | 1 |

Parameter list for Fish cabinets including: -
 PROG1350F-A, PROG600F-A, PROG 400F-A,PROS400F-A

Note: For all counters adjust parameter 'DS' to NO as door switches are not fitted to these models.

| Mnem. | Definition | Min. | Max | Default | Dim. | FT |
|-------|---|------------------------------|------|---------|-------|-----|
| SCL | Readout scale | 1°C; 2°C; °F | | 2 | flag | 2 |
| SPL | Minimum setpoint [I] | -40 | SPH | 1 | °C | -1 |
| SPH | Maximum setpoint [I] | SPL | 40 | 3 | °C | 1 |
| SP | Setpoint [I] | SPL | SPH | 2 | °C | 0 |
| HYS | Thermostat hysteresis [I] | 0.1 | 10 | 3 | °K | 2 |
| CRT | Minimum compressor rest time | 0 | 30 | 2 | min. | 2 |
| CT1 | Compressor run with T1 failure | 0 | 30 | 7 | min. | 7 |
| CT2 | Compressor stop with T1 failure | 0 | 30 | 3 | min. | 3 |
| 2CD | Start delay 2nd compressor | 0 | 120 | 0 | sec. | 0 |
| DFR | Defrost frequency / 24h | 0 | 24 | 2 | 1/24h | 0 |
| DLI | Defrost end temperature | -40 | 40 | 20 | °C | 20 |
| DTO | Maximum defrost duration | 1 | 120 | 20 | min. | 20 |
| DTY | Defrost type | OFF; ELE; GAS | | OFF | flag | OFF |
| DRN | Drain down time | 0 | 30 | 2 | min. | 2 |
| DDY | Defrost display control | 0 | 60 | 10 | min. | 10 |
| FID | Fan activity during defrost | NO | YES | YES | flag | YES |
| FDD | Fan re-start delay temperature | -40 | 40 | 0 | °C | 0 |
| FTO | Evaporator fan maximum time-out | 0 | 120 | 3 | min. | 3 |
| FTC | Evaporator fan timed control | NO | YES | YES | flag | YES |
| FT1 | Fan stop delay | 0 | 180 | 15 | sec. | 15 |
| FT2 | Timed fan stop | 0 | 30 | 2 | min. | 2 |
| FT3 | Timed fan run | 0 | 30 | 1 | min. | 1 |
| ATL | Low alarm differential | -12 | 0 | -5 | °K | -5 |
| ATH | High alarm differential | 0 | 12 | 5 | °K | 5 |
| ATD | Alarm Temperature Delay | 0 | 120 | 90 | min. | 90 |
| AHT | Condenser Alarm Temperature | 0 | 75 | 60 | °C | 60 |
| AHM | Condenser high temp. alarm operation | NON; ALR; STP | | NON | flag | NON |
| ACC | Condenser cleaning period | 0 | 52 | 0 | wks | 0 |
| HDS | Sensitivity function eco / heavy duty | 1 | 5 | 3 | flag | 3 |
| IISM | 2nd parameter set switching mode | NON; MAN; HDD; DI2 | | HDD | flag | HDD |
| IISL | Minimum 2nd temp. set | -40 | IISH | 1 | °C | 1 |
| IISH | Maximum 2nd temp. set | IISL | 40 | 3 | °C | 3 |
| IISP | Effective 2nd temperature set point | IISL | IISH | 1 | °C | 1 |
| IIHY | Hysteresis 2nd temperature set | 0.1 | 10 | 3 | °K | 3 |
| IIFT | Evap. fan timed control in mode 2 | NO | YES | NO | flag | NO |
| IIDF | Defrost Frequency / 24h in mode 2 | 0 | 24 | 4 | 1/24h | 4 |
| SB | Button 0/1 enabling | NO | YES | YES | flag | YES |
| DS | Door switch enabling | NO | YES | YES | flag | YES |
| CSD | Compressor stop delay from door opening | 0 | 30 | 1 | min. | 1 |
| ADO | Door alarm delay | 0 | 30 | 8 | min. | 8 |
| D12 | Function digital input D12 | NON; HPS; IISM; RDS | | NON | flag | NON |
| LSM | Light switch mode | NON; MAN; DOR | | NON | flag | NON |
| OAU | Control of AUX output | NON; 0-1; LGT; 2CU; 2EU; ALR | | NON | flag | NON |
| OS1 | T1 (air) probe offset | -12 | 12 | 0 | °K | 0 |
| T2 | T2 (evap.) probe enabling | NO | YES | NO | flag | NO |
| OS2 | T2 (evap.) probe offset | -12 | 12 | 0 | °K | 0 |
| T3 | T3 (cond.) probe enabling | NO | YES | NO | flag | NO |
| OS3 | T3 (cond.) probe offset | -12 | 12 | 0 | °K | 0 |
| T4 | T4 (aux.) probe enabling | NON; 2CU; 2EU | | NON | flag | NON |
| OS4 | T4 (aux.) probe offset | -12 | 12 | 0 | °K | 0 |
| TLD | Delay for min./max. temp storage | 1 | 30 | 5 | min. | 5 |
| SIM | Display slowdown | 0 | 100 | 3 | exp. | 3 |
| ADR | Unit peripheral address | 1 | 255 | 1 | exp. | 1 |

Parameter list for Wine cabinets including: -
PROG600W-A, PROG1350W-A, PROG400W-A,

Note: For all counters adjust parameter 'DS' to NO as door switches are not fitted to these models.

| Mnem. | Definition | Min. | Max | Default | Dim. | WT |
|-------|---|------------------------------|------|---------|-------|-----|
| SCL | Readout scale | 1°C; 2°C; °F | | 2 | flag | 2 |
| SPL | Minimum setpoint [I] | -40 | SPH | 1 | °C | 8 |
| SPH | Maximum setpoint [I] | SPL | 40 | 3 | °C | 12 |
| SP | Setpoint [I] | SPL | SPH | 2 | °C | 10 |
| HYS | Thermostat hysteresis [I] | 0.1 | 10 | 3 | °K | 2 |
| CRT | Minimum compressor rest time | 0 | 30 | 2 | min. | 2 |
| CT1 | Compressor run with T1 failure | 0 | 30 | 7 | min. | 7 |
| CT2 | Compressor stop with T1 failure | 0 | 30 | 3 | min. | 3 |
| 2CD | Start delay 2nd compressor | 0 | 120 | 0 | sec. | 0 |
| DFR | Defrost frequency / 24h | 0 | 24 | 2 | 1/24h | 4 |
| DLI | Defrost end temperature | -40 | 40 | 20 | °C | 20 |
| DTO | Maximum defrost duration | 1 | 120 | 20 | min. | 20 |
| DTY | Defrost type | OFF; ELE; GAS | | OFF | flag | OFF |
| DRN | Drain down time | 0 | 30 | 2 | min. | 2 |
| DDY | Defrost display control | 0 | 60 | 10 | min. | 10 |
| FID | Fan activity during defrost | NO | YES | YES | flag | YES |
| FDD | Fan re-start delay temperature | -40 | 40 | 0 | °C | 0 |
| FTO | Evaporator fan maximum time-out | 0 | 120 | 3 | min. | 3 |
| FTC | Evaporator fan timed control | NO | YES | YES | flag | YES |
| FT1 | Fan stop delay | 0 | 180 | 15 | sec. | 15 |
| FT2 | Timed fan stop | 0 | 30 | 2 | min. | 2 |
| FT3 | Timed fan run | 0 | 30 | 1 | min. | 1 |
| ATL | Low alarm differential | -12 | 0 | -5 | °K | -5 |
| ATH | High alarm differential | 0 | 12 | 5 | °K | 5 |
| ATD | Alarm Temperature Delay | 0 | 120 | 90 | min. | 90 |
| AHT | Condenser Alarm Temperature | 0 | 75 | 60 | °C | 60 |
| AHM | Condenser high temp. alarm operation | NON; ALR; STP | | NON | flag | NON |
| ACC | Condenser cleaning period | 0 | 52 | 0 | wks | 0 |
| HDS | Sensitivity function eco / heavy duty | 1 | 5 | 3 | flag | 3 |
| IISM | 2nd parameter set switching mode | NON; MAN; HDD; DI2 | | HDD | flag | HDD |
| IISL | Minimum 2nd temp. set | -40 | IISH | 1 | °C | 1 |
| IISH | Maximum 2nd temp. set | IISL | 40 | 3 | °C | 3 |
| IISP | Effective 2nd temperature set point | IISL | IISH | 1 | °C | 1 |
| IIHY | Hysteresis 2nd temperature set | 0.1 | 10 | 3 | °K | 3 |
| IIFT | Evap. fan timed control in mode 2 | NO | YES | NO | flag | NO |
| IIDF | Defrost Frequency / 24h in mode 2 | 0 | 24 | 4 | 1/24h | 4 |
| SB | Button 0/1 enabling | NO | YES | YES | flag | YES |
| DS | Door switch enabling | NO | YES | YES | flag | YES |
| CSD | Compressor stop delay from door opening | 0 | 30 | 1 | min. | 1 |
| ADO | Door alarm delay | 0 | 30 | 8 | min. | 8 |
| D12 | Function digital input D12 | NON; HPS; IISM; RDS | | NON | flag | NON |
| LSM | Light switch mode | NON; MAN; DOR | | NON | flag | NON |
| OAU | Control of AUX output | NON; 0-1; LGT; 2CU; 2EU; ALR | | NON | flag | NON |
| OS1 | T1 (air) probe offset | -12 | 12 | 0 | °K | 0 |
| T2 | T2 (evap.) probe enabling | NO | YES | NO | flag | NO |
| OS2 | T2 (evap.) probe offset | -12 | 12 | 0 | °K | 0 |
| T3 | T3 (cond.) probe enabling | NO | YES | NO | flag | NO |
| OS3 | T3 (cond.) probe offset | -12 | 12 | 0 | °K | 0 |
| T4 | T4 (aux.) probe enabling | NON; 2CU; 2EU | | NON | flag | NON |
| OS4 | T4 (aux.) probe offset | -12 | 12 | 0 | °K | 0 |
| TLD | Delay for min./max. temp storage | 1 | 30 | 5 | min. | 5 |
| SIM | Display slowdown | 0 | 100 | 3 | exp. | 3 |
| ADR | Unit peripheral address | 1 | 255 | 1 | exp. | 1 |

Parameter list for Bakery Models including: -
 Greggs 20BSR, Greggs 40BSR, PRO 20BSR, PRO 40BSR.

PRO 68HB: Adjust parameter 'SPL' to '1'.

| Mnem. | Definition | Min. | Max | Default | Dim. | BSR20 / BSR40 |
|-------|---|------------------------------|------|---------|-------|---------------|
| SCL | Readout scale | 1°C; 2°C; °F | | 2 | flag | 2 |
| SPL | Minimum setpoint [I] | -40 | SPH | 1 | °C | 0 |
| SPH | Maximum setpoint [I] | SPL | 40 | 3 | °C | 10 |
| SP | Setpoint [I] | SPL | SPH | 2 | °C | 2 |
| HYS | Thermostat hysteresis [I] | 0.1 | 10 | 3 | °K | 3 |
| CRT | Minimum compressor rest time | 0 | 30 | 2 | min. | 2 |
| CT1 | Compressor run with T1 failure | 0 | 30 | 7 | min. | 7 |
| CT2 | Compressor stop with T1 failure | 0 | 30 | 3 | min. | 3 |
| 2CD | Start delay 2nd compressor | 0 | 120 | 0 | sec. | 0 |
| DFR | Defrost frequency / 24h | 0 | 24 | 2 | 1/24h | 6 |
| DLI | Defrost end temperature | -40 | 40 | 20 | °C | 20 |
| DTO | Maximum defrost duration | 1 | 120 | 20 | min. | 20 |
| DTY | Defrost type | OFF; ELE; GAS | | OFF | flag | OFF |
| DRN | Drain down time | 0 | 30 | 2 | min. | 2 |
| DDY | Defrost display control | 0 | 60 | 10 | min. | 10 |
| FID | Fan activity during defrost | NO | YES | YES | flag | YES |
| FDD | Fan re-start delay temperature | -40 | 40 | 0 | °C | 10 |
| FTO | Evaporator fan maximum time-out | 0 | 120 | 3 | min. | 3 |
| FTC | Evaporator fan timed control | NO | YES | YES | flag | YES |
| FT1 | Fan stop delay | 0 | 180 | 15 | sec. | 15 |
| FT2 | Timed fan stop | 0 | 30 | 2 | min. | 2 |
| FT3 | Timed fan run | 0 | 30 | 1 | min. | 1 |
| ATL | Low alarm differential | -12 | 0 | -5 | °K | -5 |
| ATH | High alarm differential | 0 | 12 | 5 | °K | 5 |
| ATD | Alarm Temperature Delay | 0 | 120 | 90 | min. | 90 |
| AHT | Condenser Alarm Temperature | 0 | 75 | 60 | °C | 60 |
| AHM | Condenser high temp. alarm operation | NON; ALR; STP | | NON | flag | NON |
| ACC | Condenser cleaning period | 0 | 52 | 0 | wks | 0 |
| HDS | Sensitivity function eco / heavy duty | 1 | 5 | 3 | flag | 3 |
| IISM | 2nd parameter set switching mode | NON; MAN; HDD; DI2 | | HDD | flag | HDD |
| IISL | Minimum 2nd temp. set | -40 | IISH | 1 | °C | 0 |
| IISH | Maximum 2nd temp. set | IISL | 40 | 3 | °C | 10 |
| IISP | Effective 2nd temperature set point | IISL | IISH | 1 | °C | 1 |
| IIHY | Hysteresis 2nd temperature set | 0.1 | 10 | 3 | °K | 3 |
| IIFT | Evap. fan timed control in mode 2 | NO | YES | NO | flag | NO |
| IIDF | Defrost Frequency / 24h in mode 2 | 0 | 24 | 4 | 1/24h | 4 |
| SB | Button 0/1 enabling | NO | YES | YES | flag | YES |
| DS | Door switch enabling | NO | YES | YES | flag | YES |
| CSD | Compressor stop delay from door opening | 0 | 30 | 1 | min. | 1 |
| ADO | Door alarm delay | 0 | 30 | 8 | min. | 8 |
| D12 | Function digital input D12 | NON; HPS; IISM; RDS | | NON | flag | NON |
| LSM | Light switch mode | NON; MAN; DOR | | NON | flag | NON |
| OAU | Control of AUX output | NON; 0-1; LGT; 2CU; 2EU; ALR | | NON | flag | NON |
| OS1 | T1 (air) probe offset | -12 | 12 | 0 | °K | 0 |
| T2 | T2 (evap.) probe enabling | NO | YES | NO | flag | NO |
| OS2 | T2 (evap.) probe offset | -12 | 12 | 0 | °K | 0 |
| T3 | T3 (cond.) probe enabling | NO | YES | NO | flag | NO |
| OS3 | T3 (cond.) probe offset | -12 | 12 | 0 | °K | 0 |
| T4 | T4 (aux.) probe enabling | NON; 2CU; 2EU | | NON | flag | NON |
| OS4 | T4 (aux.) probe offset | -12 | 12 | 0 | °K | 0 |
| TLD | Delay for min./max. temp storage | 1 | 30 | 5 | min. | 5 |
| SIM | Display slowdown | 0 | 100 | 3 | exp. | 3 |
| ADR | Unit peripheral address | 1 | 255 | 1 | exp. | 1 |

Parameter list for Bakery Models including: -
 Greggs 20BSF, Greggs 40BSF, PRO 20BSF, PRO 40BSF.

PRO 68LB: Adjust parameter 'SPL' to '-30', 'SPH' to '5', 'SP' to '-18' and 'dFr' to '4'.

| Mnem. | Definition | Min. | Max | Default | Dim. | BSF20 / BSF40 |
|-------|---|------------------------------|------|---------|-------|---------------|
| SCL | Readout scale | 1°C; 2°C; °F | | 2 | flag | 2 |
| SPL | Minimum setpoint [I] | -40 | SPH | 1 | °C | -21 |
| SPH | Maximum setpoint [I] | SPL | 40 | 3 | °C | -18 |
| SP | Setpoint [I] | SPL | SPH | 2 | °C | -19 |
| HYS | Thermostat hysteresis [I] | 0.1 | 10 | 3 | °K | 3 |
| CRT | Minimum compressor rest time | 0 | 30 | 2 | min. | 2 |
| CT1 | Compressor run with T1 failure | 0 | 30 | 7 | min. | 7 |
| CT2 | Compressor stop with T1 failure | 0 | 30 | 3 | min. | 3 |
| 2CD | Start delay 2nd compressor | 0 | 120 | 0 | sec. | 0 |
| DFR | Defrost frequency / 24h | 0 | 24 | 2 | 1/24h | 6 |
| DLI | Defrost end temperature | -40 | 40 | 20 | °C | 20 |
| DTO | Maximum defrost duration | 1 | 120 | 20 | min. | 20 |
| DTY | Defrost type | OFF; ELE; GAS | | OFF | flag | GAS |
| DRN | Drain down time | 0 | 30 | 2 | min. | 2 |
| DDY | Defrost display control | 0 | 60 | 10 | min. | 10 |
| FID | Fan activity during defrost | NO | YES | YES | flag | NO |
| FDD | Fan re-start delay temperature | -40 | 40 | 0 | °C | 0 |
| FTO | Evaporator fan maximum time-out | 0 | 120 | 3 | min. | 3 |
| FTC | Evaporator fan timed control | NO | YES | YES | flag | YES |
| FT1 | Fan stop delay | 0 | 180 | 15 | sec. | 15 |
| FT2 | Timed fan stop | 0 | 30 | 2 | min. | 3 |
| FT3 | Timed fan run | 0 | 30 | 1 | min. | 1 |
| ATL | Low alarm differential | -12 | 0 | -5 | °K | -5 |
| ATH | High alarm differential | 0 | 12 | 5 | °K | 5 |
| ATD | Alarm Temperature Delay | 0 | 120 | 90 | min. | 90 |
| AHT | Condenser Alarm Temperature | 0 | 75 | 60 | °C | 60 |
| AHM | Condenser high temp. alarm operation | NON; ALR; STP | | NON | flag | NON |
| ACC | Condenser cleaning period | 0 | 52 | 0 | wks | 0 |
| HDS | Sensitivity function eco / heavy duty | 1 | 5 | 3 | flag | 3 |
| IISM | 2nd parameter set switching mode | NON; MAN; HDD; DI2 | | HDD | flag | HDD |
| IISL | Minimum 2nd temp. set | -40 | IISH | 1 | °C | -25 |
| IISH | Maximum 2nd temp. set | IISL | 40 | 3 | °C | -15 |
| IISP | Effective 2nd temperature set point | IISL | IISH | 1 | °C | -21 |
| IIHY | Hysteresis 2nd temperature set | 0.1 | 10 | 3 | °K | 3 |
| IIFT | Evap. fan timed control in mode 2 | NO | YES | NO | flag | NO |
| IIDF | Defrost Frequency / 24h in mode 2 | 0 | 24 | 4 | 1/24h | 4 |
| SB | Button 0/1 enabling | NO | YES | YES | flag | YES |
| DS | Door switch enabling | NO | YES | YES | flag | YES |
| CSD | Compressor stop delay from door opening | 0 | 30 | 1 | min. | 1 |
| ADO | Door alarm delay | 0 | 30 | 8 | min. | 8 |
| D12 | Function digital input D12 | NON; HPS; IISM; RDS | | NON | flag | NON |
| LSM | Light switch mode | NON; MAN; DOR | | NON | flag | NON |
| OAU | Control of AUX output | NON; 0-1; LGT; 2CU; 2EU; ALR | | NON | flag | NON |
| OS1 | T1 (air) probe offset | -12 | 12 | 0 | °K | 0 |
| T2 | T2 (evap.) probe enabling | NO | YES | NO | flag | YES |
| OS2 | T2 (evap.) probe offset | -12 | 12 | 0 | °K | 0 |
| T3 | T3 (cond.) probe enabling | NO | YES | NO | flag | NO |
| OS3 | T3 (cond.) probe offset | -12 | 12 | 0 | °K | 0 |
| T4 | T4 (aux.) probe enabling | NON; 2CU; 2EU | | NON | flag | NON |
| OS4 | T4 (aux.) probe offset | -12 | 12 | 0 | °K | 0 |
| TLD | Delay for min./max. temp storage | 1 | 30 | 5 | min. | 5 |
| SIM | Display slowdown | 0 | 100 | 3 | exp. | 3 |
| ADR | Unit peripheral address | 1 | 255 | 1 | exp. | 1 |

Parameter list for Bakery Models including: -
PRO 16DR, PRO 16VE, PRO 24VE, DR 16VE and DR 24VE.

PRO 20DR, PRO 40DR. Adjust parameter 'SPL' to '-5', 'SPH' to '10', 'SP' to '-4' and 'FDD' to '-8'

| Mnem. | Definition | Min. | Max | Default | Dim. | Pro 16 Pro 24 DR 16 DR 24 |
|-------|---|------------------------------|------|---------|-------|------------------------------------|
| SCL | Readout scale | 1°C; 2°C; °F | | 2 | flag | 2 |
| SPL | Minimum setpoint [I] | -40 | SPH | 1 | °C | -4 |
| SPH | Maximum setpoint [I] | SPL | 40 | 3 | °C | -4 |
| SP | Setpoint [I] | SPL | SPH | 2 | °C | -4 |
| HYS | Thermostat hysteresis [I] | 0.1 | 10 | 3 | °K | 2 |
| CRT | Minimum compressor rest time | 0 | 30 | 2 | min. | 2 |
| CT1 | Compressor run with T1 failure | 0 | 30 | 7 | min. | 7 |
| CT2 | Compressor stop with T1 failure | 0 | 30 | 3 | min. | 3 |
| 2CD | Start delay 2nd compressor | 0 | 120 | 0 | sec. | 0 |
| DFR | Defrost frequency / 24h | 0 | 24 | 2 | 1/24h | 3 |
| DLI | Defrost end temperature | -40 | 40 | 20 | °C | 20 |
| DTO | Maximum defrost duration | 1 | 120 | 20 | min. | 20 |
| DTY | Defrost type | OFF; ELE; GAS | | OFF | flag | GAS |
| DRN | Drain down time | 0 | 30 | 2 | min. | 2 |
| DDY | Defrost display control | 0 | 60 | 10 | min. | 10 |
| FID | Fan activity during defrost | NO | YES | YES | flag | NO |
| FDD | Fan re-start delay temperature | -40 | 40 | 0 | °C | 8 |
| FTO | Evaporator fan maximum time-out | 0 | 120 | 3 | min. | 3 |
| FTC | Evaporator fan timed control | NO | YES | YES | flag | YES |
| FT1 | Fan stop delay | 0 | 180 | 15 | sec. | 15 |
| FT2 | Timed fan stop | 0 | 30 | 2 | min. | 2 |
| FT3 | Timed fan run | 0 | 30 | 1 | min. | 1 |
| ATL | Low alarm differential | -12 | 0 | -5 | °K | -5 |
| ATH | High alarm differential | 0 | 12 | 5 | °K | 5 |
| ATD | Alarm Temperature Delay | 0 | 120 | 90 | min. | 90 |
| AHT | Condenser Alarm Temperature | 0 | 75 | 60 | °C | 60 |
| AHM | Condenser high temp. alarm operation | NON; ALR; STP | | NON | flag | NON |
| ACC | Condenser cleaning period | 0 | 52 | 0 | wks | 0 |
| HDS | Sensitivity function eco / heavy duty | 1 | 5 | 3 | flag | 3 |
| IISM | 2nd parameter set switching mode | NON; MAN; HDD; DI2 | | HDD | flag | HDD |
| IISL | Minimum 2nd temp. set | -40 | IISH | 1 | °C | -4 |
| IISH | Maximum 2nd temp. set | IISL | 40 | 3 | °C | -4 |
| IISP | Effective 2nd temperature set point | IISL | IISH | 1 | °C | -4 |
| IIHY | Hysteresis 2nd temperature set | 0.1 | 10 | 3 | °K | 2 |
| IIFT | Evap. fan timed control in mode 2 | NO | YES | NO | flag | NO |
| IIDF | Defrost Frequency / 24h in mode 2 | 0 | 24 | 4 | 1/24h | 6 |
| SB | Button 0/1 enabling | NO | YES | YES | flag | YES |
| DS | Door switch enabling | NO | YES | YES | flag | NO |
| CSD | Compressor stop delay from door opening | 0 | 30 | 1 | min. | 1 |
| ADO | Door alarm delay | 0 | 30 | 8 | min. | 5 |
| D12 | Function digital input D12 | NON; HPS; IISM; RDS | | NON | flag | NON |
| LSM | Light switch mode | NON; MAN; DOR | | NON | flag | NON |
| OAU | Control of AUX output | NON; 0-1; LGT; 2CU; 2EU; ALR | | NON | flag | NON |
| OS1 | T1 (air) probe offset | -12 | 12 | 0 | °K | 0 |
| T2 | T2 (evap.) probe enabling | NO | YES | NO | flag | YES |
| OS2 | T2 (evap.) probe offset | -12 | 12 | 0 | °K | 0 |
| T3 | T3 (cond.) probe enabling | NO | YES | NO | flag | NO |
| OS3 | T3 (cond.) probe offset | -12 | 12 | 0 | °K | 0 |
| T4 | T4 (aux.) probe enabling | NON; 2CU; 2EU | | NON | flag | NON |
| OS4 | T4 (aux.) probe offset | -12 | 12 | 0 | °K | 0 |
| TLD | Delay for min./max. temp storage | 1 | 30 | 5 | min. | 5 |
| SIM | Display slowdown | 0 | 100 | 3 | exp. | 3 |
| ADR | Unit peripheral address | 1 | 255 | 1 | exp. | 1 |

TECHNICAL DATA PRO CABINETS

| Model | Gas | Gas Charge | Compressor | Capillary | Defrost Type | Voltage | Power Consumption | | Fuse Rating |
|--------------------|-------|------------|------------|--------------|--------------------|----------|-------------------|------|-------------|
| | | | | | | | Watts | Amps | |
| PRO S 400H-A | R134A | 350 grms | GL80TB | 3.0m x 0.042 | Timed Off Cycle | 230-1-50 | 295 | 2.1 | 10 Amp |
| PRO S 400M-A | R134A | 350 grms | GL80TB | 3.0m x 0.042 | Hot Gas | 230-1-50 | 329 | 2.2 | 10 Amp |
| PRO S 400L-A | R404A | 420 grms | SC15CLX | 3.0m x 0.042 | Hot Gas | 230-1-50 | 641 | 3.1 | 10 Amp |
| PREM S 400F | R134A | 210 grms | GL90TB | 3.0m x 0.054 | Timed Off Cycle | 230-1-50 | 289 | 1.9 | 10 Amp |
| PRO G 500H-A | R134A | 350 grms | GL90TB | 3.0m x 0.042 | Timed Off Cycle | 230-1-50 | 295 | 2.1 | 10 Amp |
| PRO G 500M-A | R134A | 350 grms | GL90TB | 3.0m x 0.042 | Hot Gas | 230-1-50 | 329 | 2.2 | 10 Amp |
| PRO G 500L-A | R404A | 420 grms | SC15CLX | 3.0m x 0.042 | Hot Gas | 230-1-50 | 641 | 3.1 | 10 Amp |
| PRO G 600H-A | R134A | 350 grms | GL90TB | 3.0m x 0.042 | Timed Off Cycle | 230-1-50 | 349 | 2.5 | 10 Amp |
| PRO G 600M-A | R134A | 350 grms | GL90TB | 3.0m x 0.042 | Hot Gas | 230-1-50 | 389 | 2.7 | 10 Amp |
| PRO G 600L-A | R404A | 420 grms | ML60TB | 3.0m x 0.054 | Hot Gas | 230-1-50 | 709 | 3.4 | 13 Amp |
| PREM G 600F | R134A | 210 grms | GL90TB | 3.0m x 0.054 | Timed Off Cycle | 230-1-50 | 349 | 2.4 | 10 Amp |
| PRO G 1100H-A | R134A | 400 grms | MP12TB | 3.0m x 0.054 | Timed Off Cycle | 230-1-50 | 567 | 3.8 | 10 Amp |
| PRO G 1100M-A | R134A | 400 grms | MP12TB | 3.0m x 0.054 | Hot Gas | 230-1-50 | 638 | 4.1 | 10 Amp |
| PRO G 1100L-A | R404A | 500 grms | MS26FB-T | 3.0m x 0.054 | Hot Gas | 230-1-50 | 920 | 4.5 | 13 Amp |
| PRO G 1350H-A | R134A | 450 grms | GP16TB | 3.0m x 0.054 | Timed Off Cycle | 230-1-50 | 655 | 4.7 | 10 Amp |
| PRO G 1350M-A | R134A | 450 grms | MP12TB | 3.0m x 0.054 | Hot Gas | 230-1-50 | 738 | 5.0 | 10 Amp |
| PRO G 1350L-A | R404A | 500 grms | MS26FB-T | 3.0m x 0.054 | Hot Gas | 230-1-50 | 934 | 4.6 | 13 Amp |
| PRO G 1350F-A | R134a | 360 gms | GP14TB | 2.5m x 0.054 | Timed Off Cycle | 230-1-50 | 1328 | 658 | 13 Amp |
| PRO G 300/300 HL-A | R134A | 210 grms | GL80TB | 3.0m x 0.042 | Timed Off Cycle | 230-1-50 | 936 | 5.1 | 10 Amp |
| | R404A | 310 grms | ML45TB | 3.0m x 0.042 | Electric | 230-1-50 | | | 13 Amp |
| PRO B 600MW-A | R404A | 480 grms | MP12TB | 3.0m x 0.064 | Hot Gas & Electric | 230-1-50 | 855 | 4.6 | 13 Amps |
| PRO B 600LW-A | R404A | 440 grms | MS26FB-T | 3.0m x 0.054 | Hot Gas & Electric | 230-1-50 | 1023 | 4.9 | 13 Amps |

Technical Data Pro Counter

| Model | Gas | Gas Charge | Compressor | Capillary | Defrost Type | Voltage | Power Consumption | | Fuse Rating |
|-------------|-------|------------|------------|--------------|-----------------|----------|-------------------|------|-------------|
| | | | | | | | Watts | Amps | |
| Pro 1/2H-A | R134A | 360 grms | GL80TB | 3m X 0.042 | Timed Off Cycle | 230/50/1 | 290 | 2 | 10 |
| Pro 1/2HP-A | R134A | 360 grms | GL80TB | 3m X 0.042 | Timed Off Cycle | 230/50/1 | 290 | 2 | 10 |
| Pro 1/2MC-A | R134A | 360 grms | GL80TB | 3m X 0.042 | Hot Gas | 230/50/1 | 330 | 2.1 | 10 |
| Pro 1/2L-A | R404A | 335 grms | SC 15CLX | 3m X 0.042 | Hot Gas | 230/50/1 | 670 | 3.2 | 10 |
| Pro 1/2F-A | R134A | 315 grms | GL80TB | 3M X 0.042 | Manual | 230/50/1 | 350 | 2.3 | 10 |
| Pro 1/3H-A | R134A | 315 grms | GL90TB | 3m X 0.042 | Timed Off Cycle | 230/50/1 | 340 | 2.4 | 10 |
| Pro 1/3HP-A | R134A | 315 grms | GL80TB | 3M X 0.042 | Timed Off Cycle | 230/50/1 | 340 | 2.4 | 10 |
| Pro 1/3MC-A | R134A | 315 grms | ML60TB | 3m X 0.042 | Hot Gas | 230/50/1 | 400 | 2.6 | 10 |
| Pro 1/3L-A | R404A | 360 grms | SC 15CLX | 2.5M X 0.042 | Hot Gas | 230/50/1 | 690 | 3.3 | 10 |
| Pro 1/3F-A | R134A | 260 grms | ML60TB | 3M X 0.042 | Manual | 230/50/1 | 370 | 2.4 | 10 |
| Pro 1/4H-A | R134A | 370 grms | ML90TB | 3M X 0.054 | Timed Off Cycle | 230/50/1 | 520 | 3.4 | 10 |
| Pro 1/4HP-A | R134A | 370 grms | ML90TB | 3M X 0.054 | Timed Off Cycle | 230/50/1 | 520 | 3.4 | 10 |
| Pro 1/4MC-A | R134A | 370 grms | ML90TB | 3m X 0.054 | Hot Gas | 230/50/1 | 600 | 3.7 | 10 |
| Pro 1/4L-A | R404A | 325 grms | SC 21CLX | 3m X 0.054 | Hot Gas | 230/50/1 | 810 | 3.8 | 13 |
| Pro 2/2H-A | R134A | 365 grms | ML60TB | 3m X 0.042 | Timed Off Cycle | 230/50/1 | 380 | 2.6 | 10 |
| Pro 2/2MC-A | R134A | 365 grms | ML60TB | 3m X 0.042 | Hot Gas | 230/50/1 | 420 | 2.8 | 10 |
| Pro 2/2L-A | R404A | 360 grms | SC 15CLX | 2.5 X 0.042 | Hot Gas | 230/50/1 | 710 | 3.4 | 10 |
| Pro 2/3H-A | R134A | 380 grms | ML90TB | 3m X 0.054 | Timed Off Cycle | 230/50/1 | 550 | 3.6 | 10 |
| Pro 2/3MC-A | R134A | 380 grms | ML90TB | 3m X 0.054 | Hot Gas | 230/50/1 | 620 | 3.9 | 10 |
| Pro 2/3L-A | R404A | 415 grms | SC 21CLX | 3m X 0.054 | Hot Gas | 230/50/1 | 840 | 4 | 13 |

Wiring Diagram for High Temperature Models

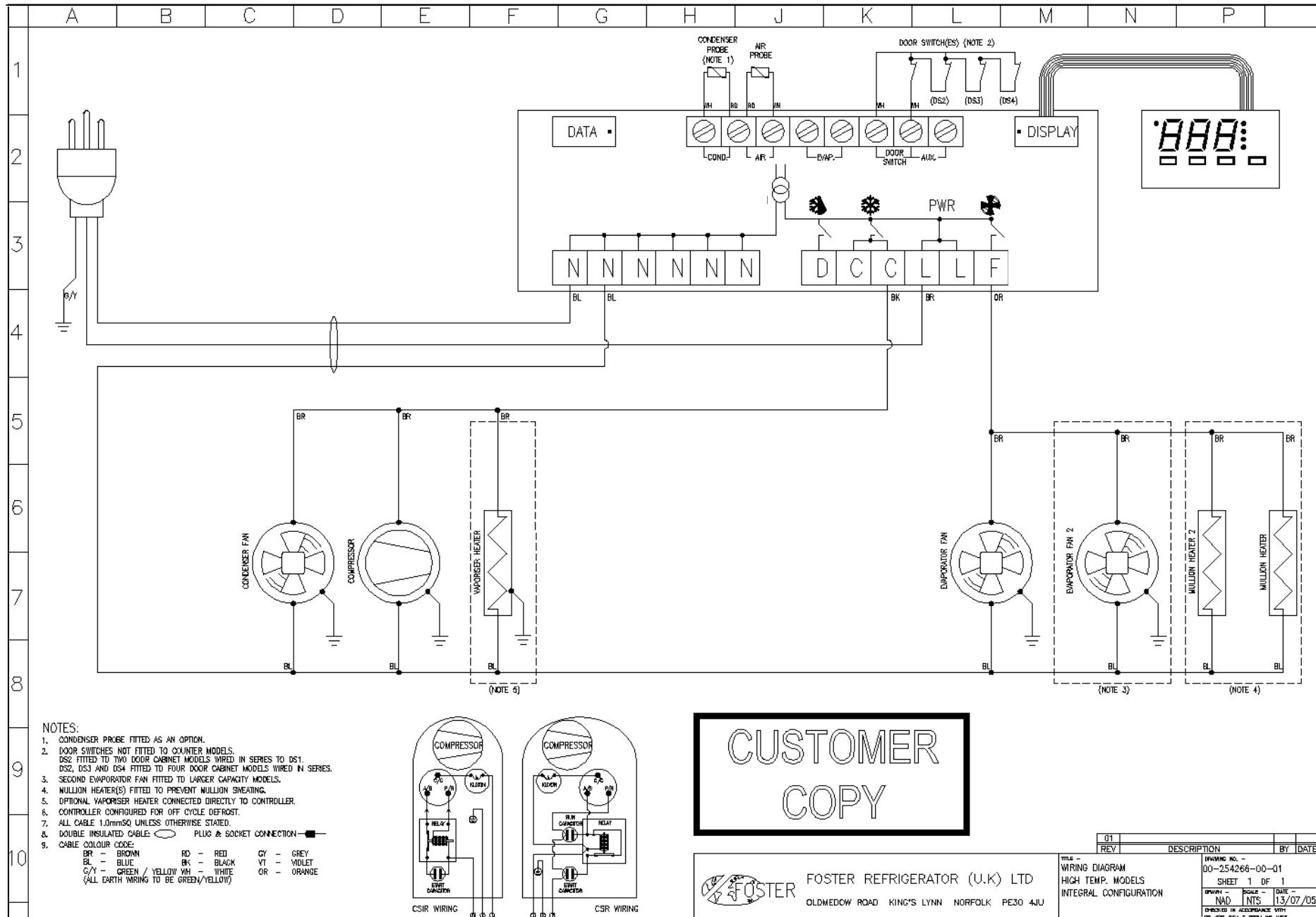

Wiring Diagram for Meat and Low Temperature Models

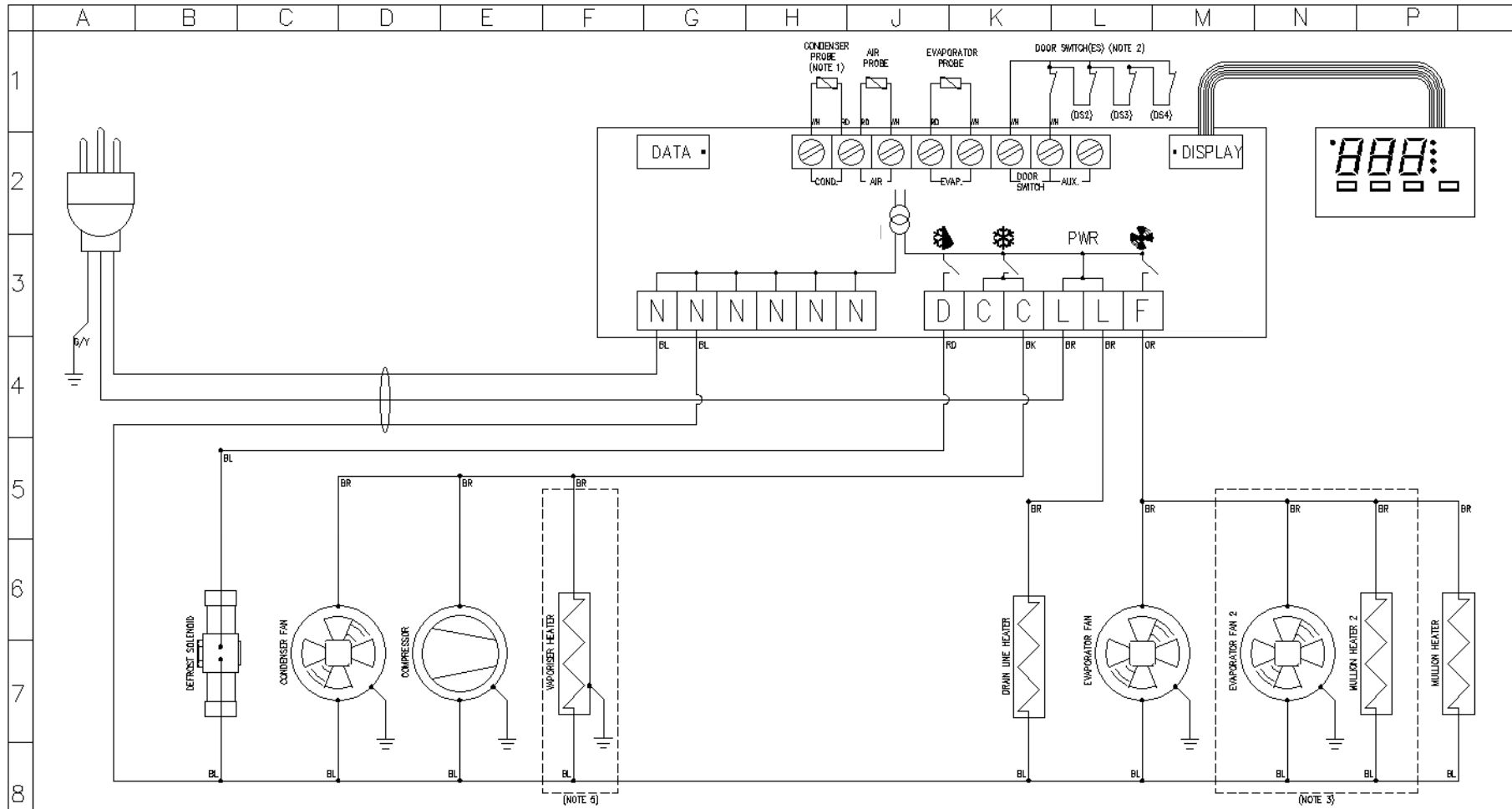

- NOTES:**
1. CONDENSER PROBE FITTED AS AN OPTION.
 2. DOOR SWITCHES NOT FITTED TO COUNTER MODELS.
DS2 FITTED TO TWO DOOR CABINET MODELS (WIRED IN SERIES TO DS1).
DS2, DS3 AND DS4 FITTED TO FOUR DOOR CABINET MODELS WIRED IN SERIES.
 3. SECOND EVAPORATOR FAN / MULLION HEATER ONLY FITTED TO LARGER CAPACITY MODELS.
 4. DRAIN LINE HEATER STANDARD IN LOW TEMPERATURE MODELS.
 5. OPTIONAL VAPORISER HEATER CONNECTED DIRECTLY TO CONTROLLER.
 6. CONTROLLER CONFIGURED FOR HOT GAS DEFROST.
 7. ALL CABLE 1.0mm² UNLESS OTHERWISE STATED.
 8. DOUBLE INSULATED CABLE: PLUG & SOCKET CONNECTION
 9. CABLE COLOUR CODE:
BR - BROWN RD - RED GY - GREY
BL - BLUE BK - BLACK VT - VIOLET
G/Y - GREEN / YELLOW WH - WHITE OR - ORANGE
(ALL EARTH WIRING TO BE GREEN/YELLOW)

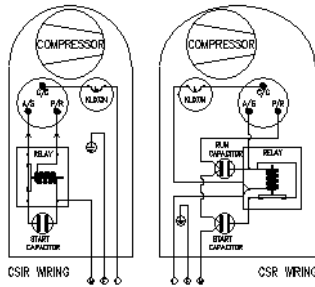

CUSTOMER COPY

FOSTER REFRIGERATOR (U.K) LTD
 OLDMEDOW ROAD KING'S LYNN NORFOLK PE30 4JU

| DI | DESCRIPTION | BY | DATE |
|-----|-------------|----|------|
| REV | | | |

| | |
|--|--|
| TITLE - WIRING DIAGRAM MEAT & LOW TEMP. MODELS INTEGRAL CONFIGURATION | DRAWING NO. - 00-254270-01 SHEET 1 OF 1 DRAWN - NAD NTS 13/07/05 CHECKED IN ACCORDANCE WITH QP-070-REV-C FROM IRL 1008 |
|--|--|



Foster European Operations

France

Foster Refrigerator France SA

Tel: (33) 01 34 30 22 22. Fax: (33) 01 30 37 68 74.

Email: commercial@fosterfrance.com

Germany

Foster Refrigerator Gmbh,

Tel: (49) 781 990 7840. Fax (49) 781 990 7844.

Email: info@foster-gmbh.de

Foster Refrigerator

Oldmedow Road

Kings Lynn

Norfolk

PE30 4JU

Tel: 01553 691122

Fax: 01553 691447

Website: www.fosterrefrigerator.co.uk

Email: sales@foster-uk.com

a Division of 'ITW (UK) Ltd'

PRO'A' LF28 CAB/COUNT/SM 03/08